

SET UP INSTRUCTION
ACCESSORIES

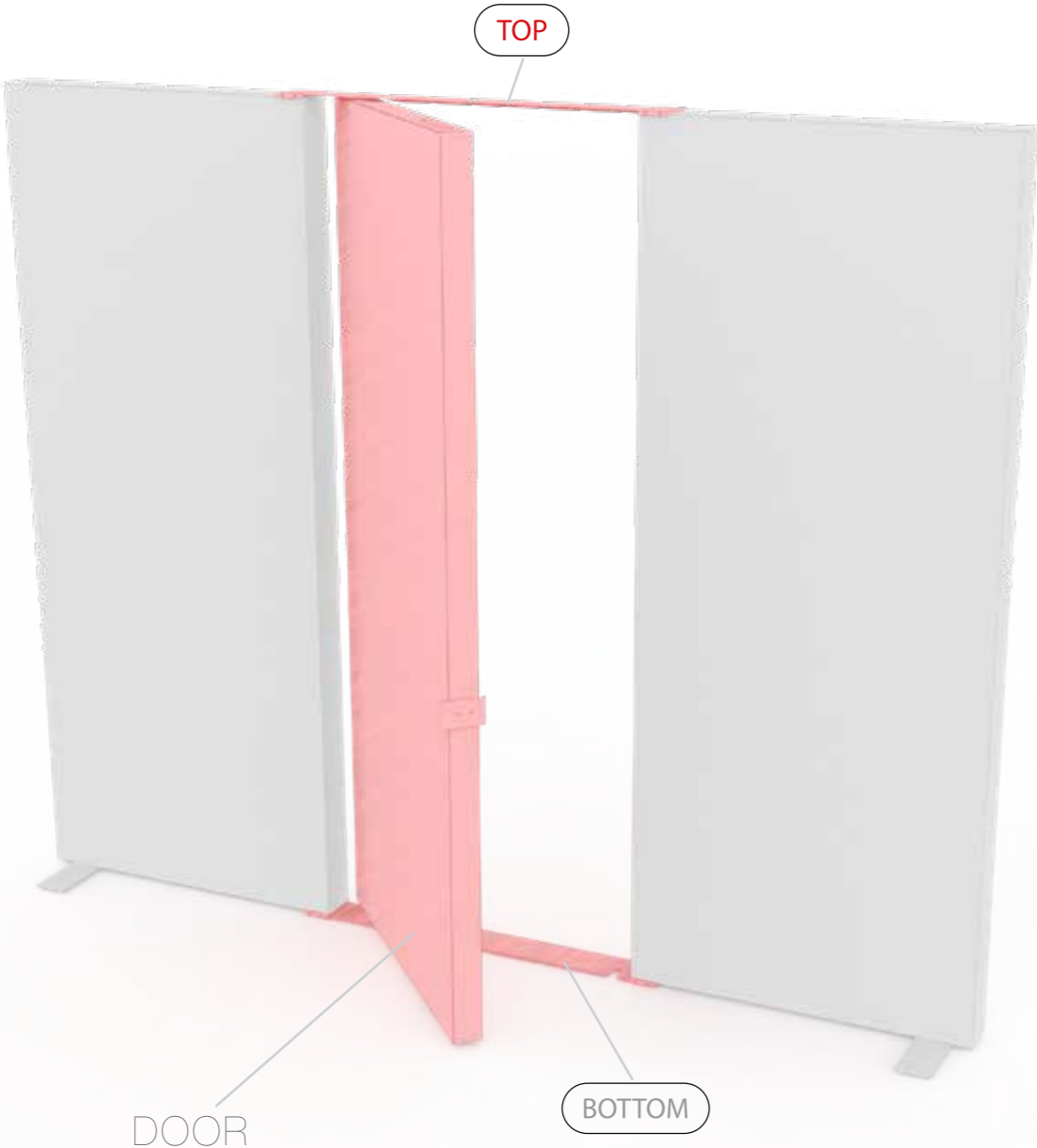

**BIG LED UP
DOOR**

The text "BIG LED UP DOOR" is rendered in a bold, stylized font. Each letter is filled with a vibrant, multi-colored gradient of blue, red, and yellow, creating a sense of motion and energy. The letters are set against a solid black background and are enclosed within a thin, bright red rectangular border.



Gerade Version/straight version 4
Aufbauanleitung/set up instruction

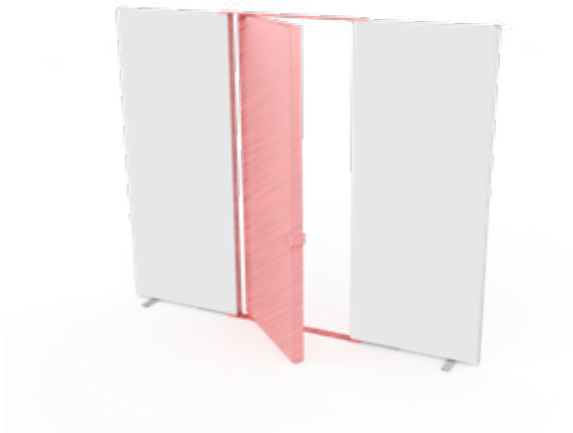

Eck- & Kojenversion/corner & storage version.....30
Aufbauanleitung/set up instruction



BIG LED UP DOOR

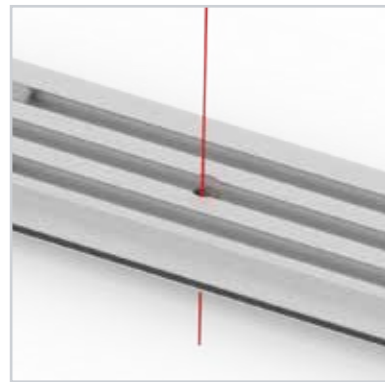

AXIS

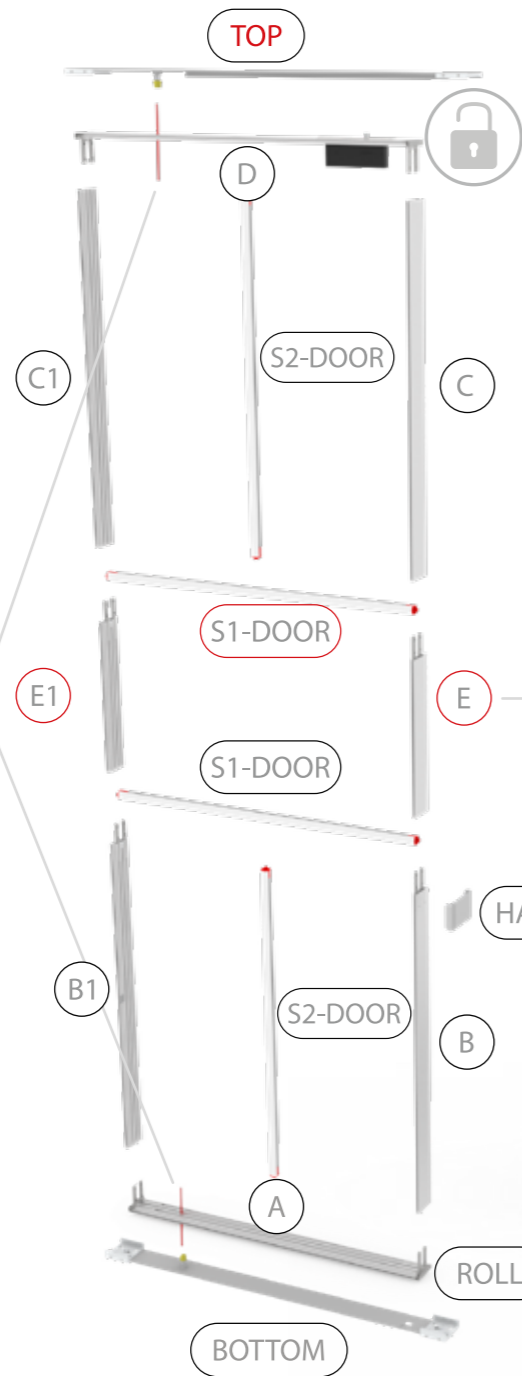

RAHMENGRÖSSE/FRAME
SIZE: 98 x 199,2 / 239,2 / 297,2cm

E1 S1-DOOR E
NUR FÜR DIE HÖHE
240/298 ERFORDERLICH
ONLY NEEDED FOR THE
HEIGHT 240/298



1.

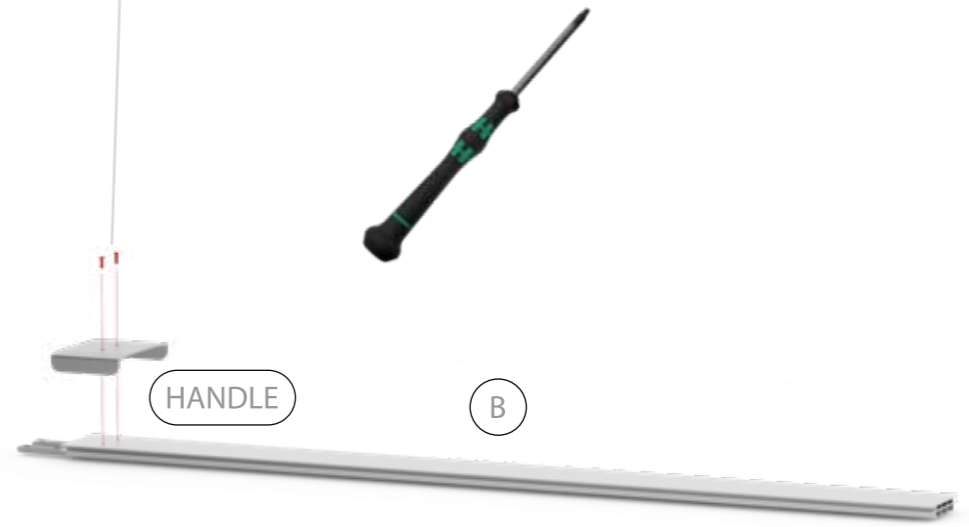

TÜR/DOOR

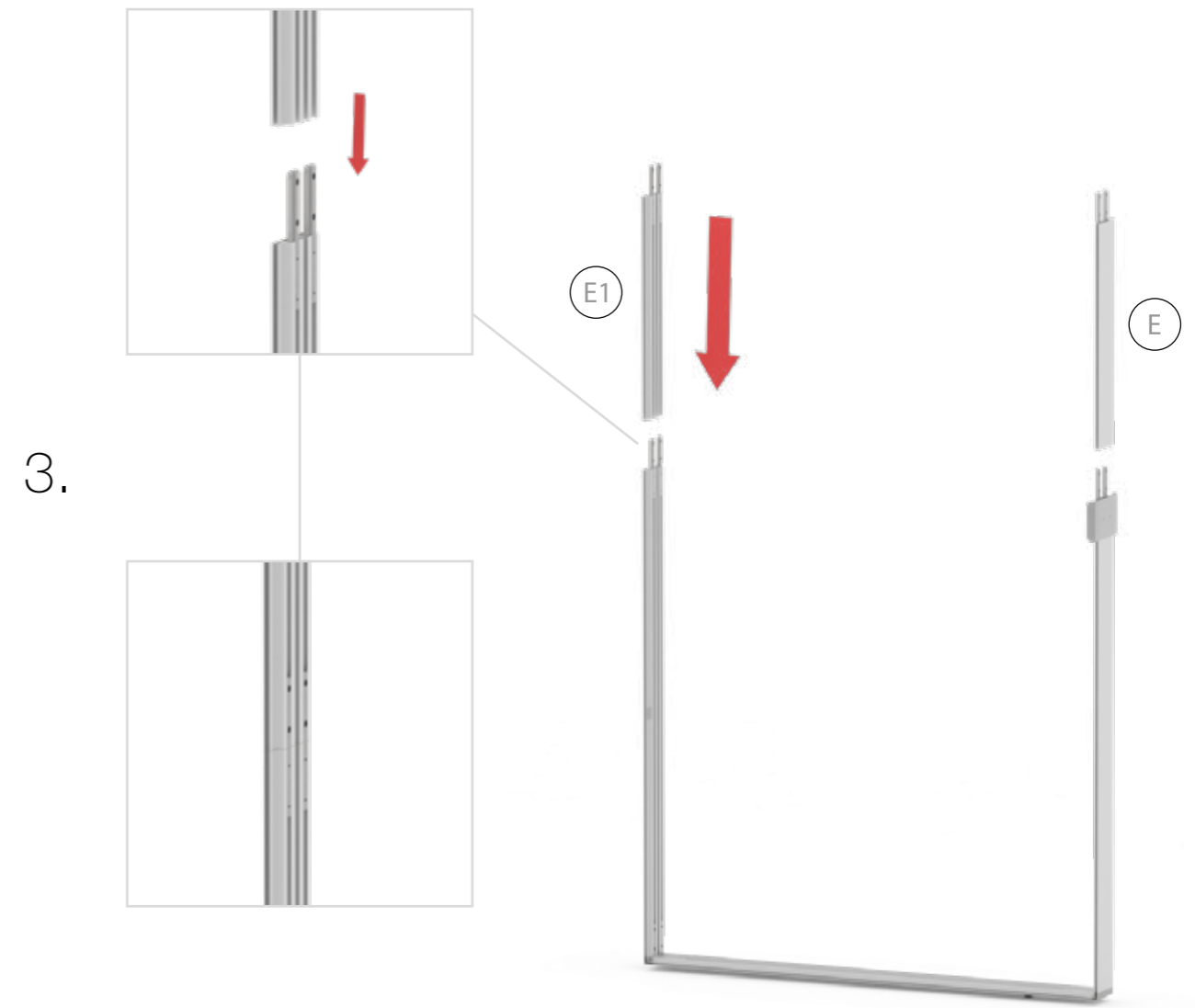
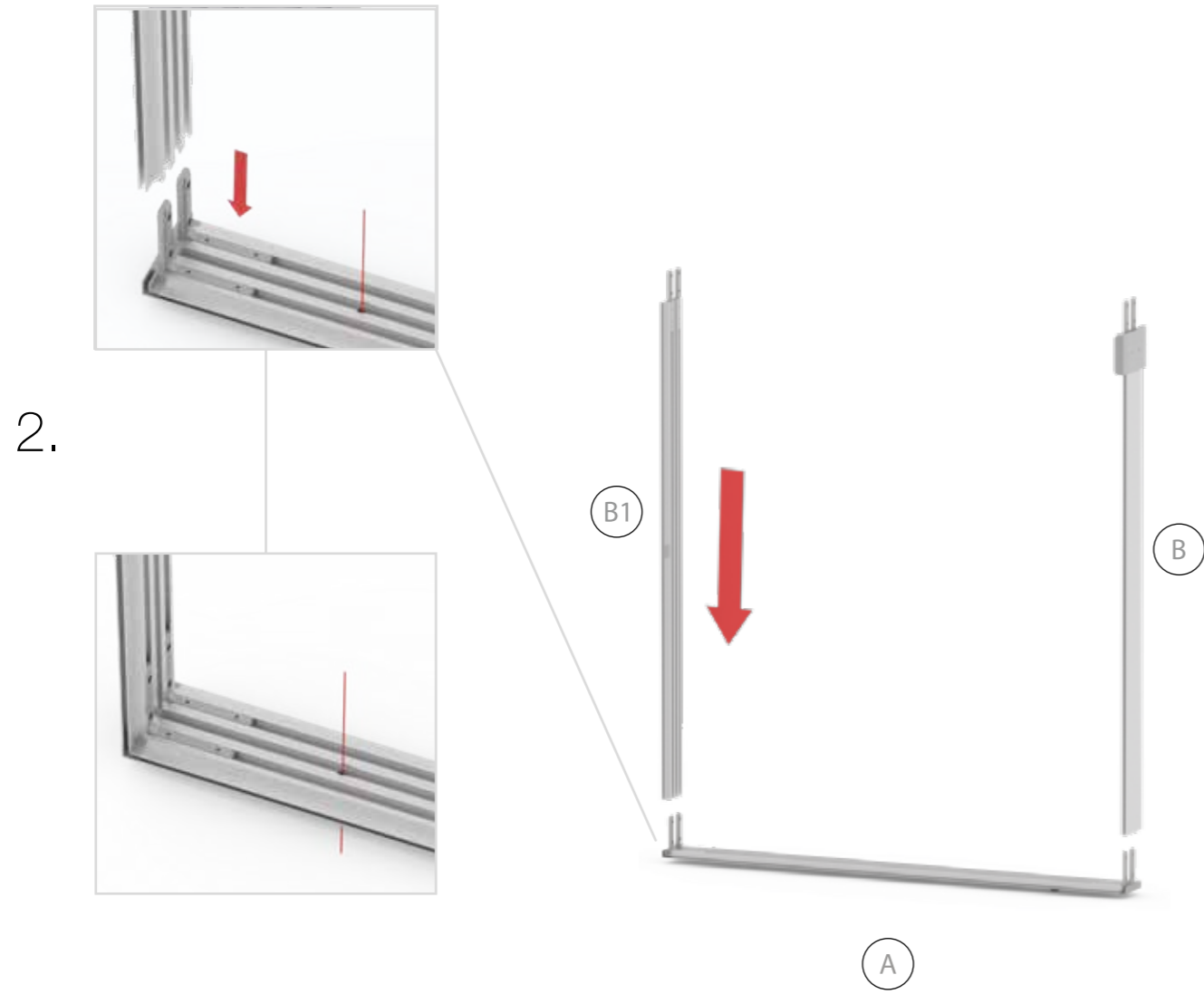

TÜR/DOOR

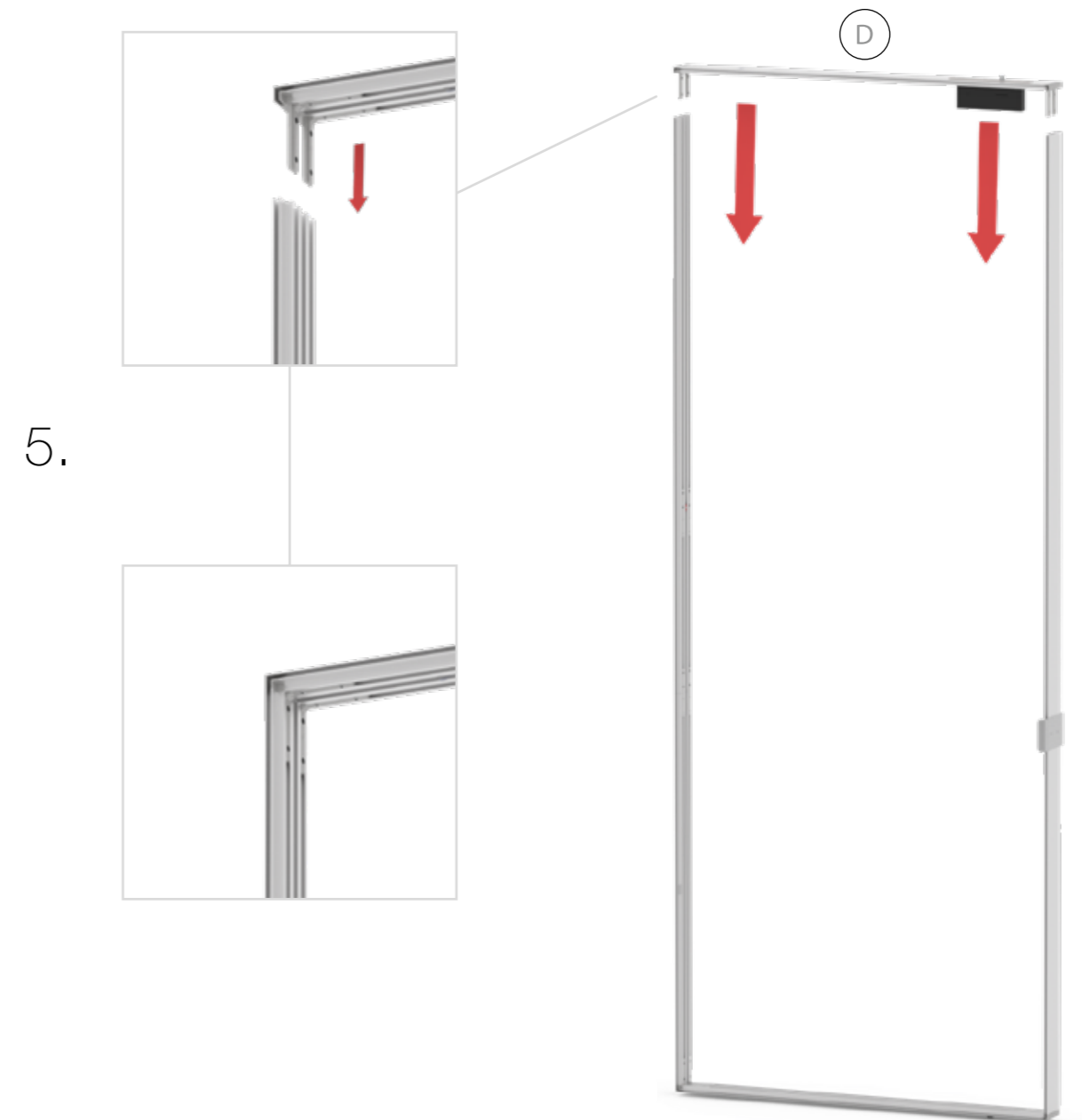
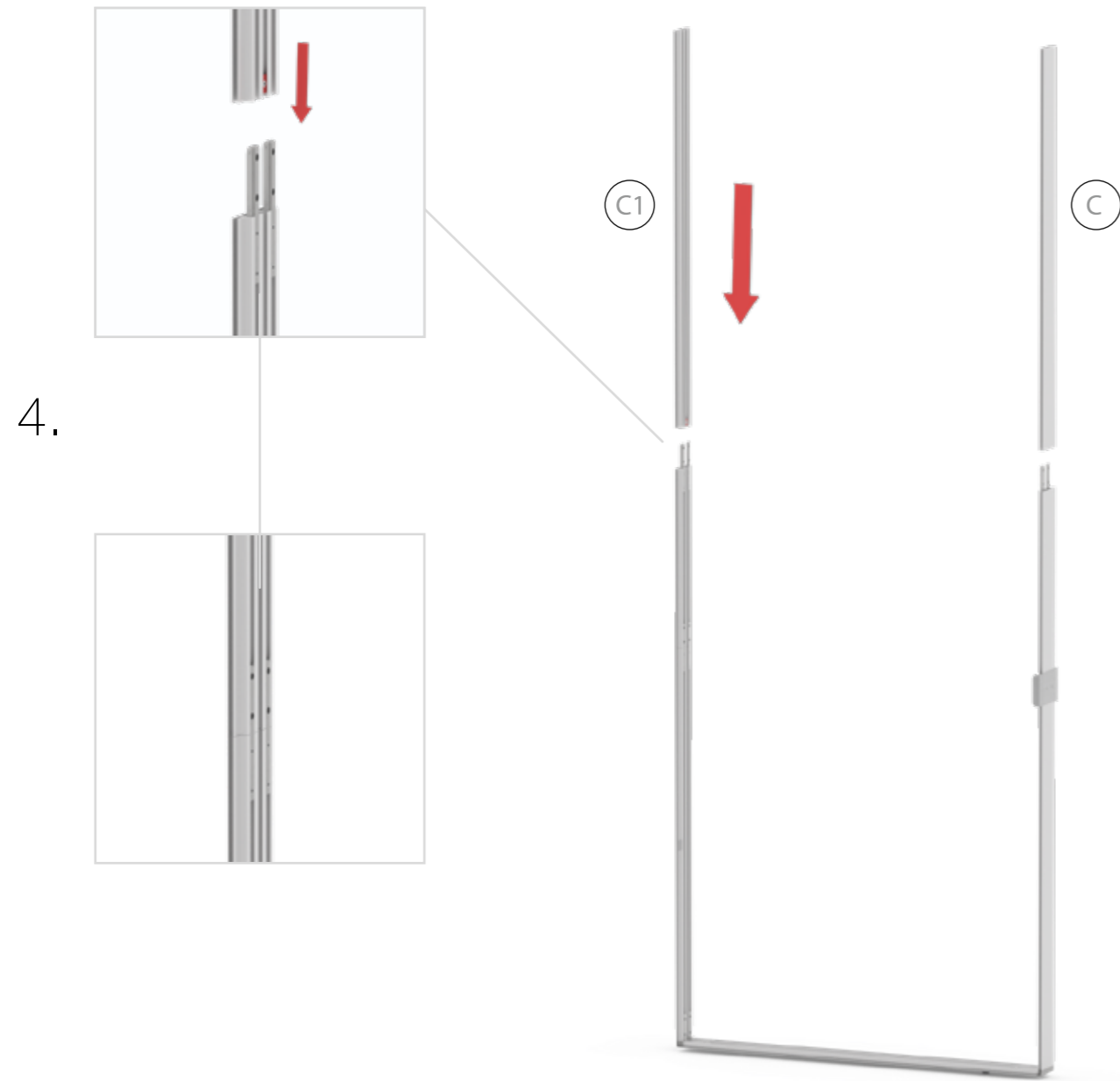

TÜR/DOOR

6.

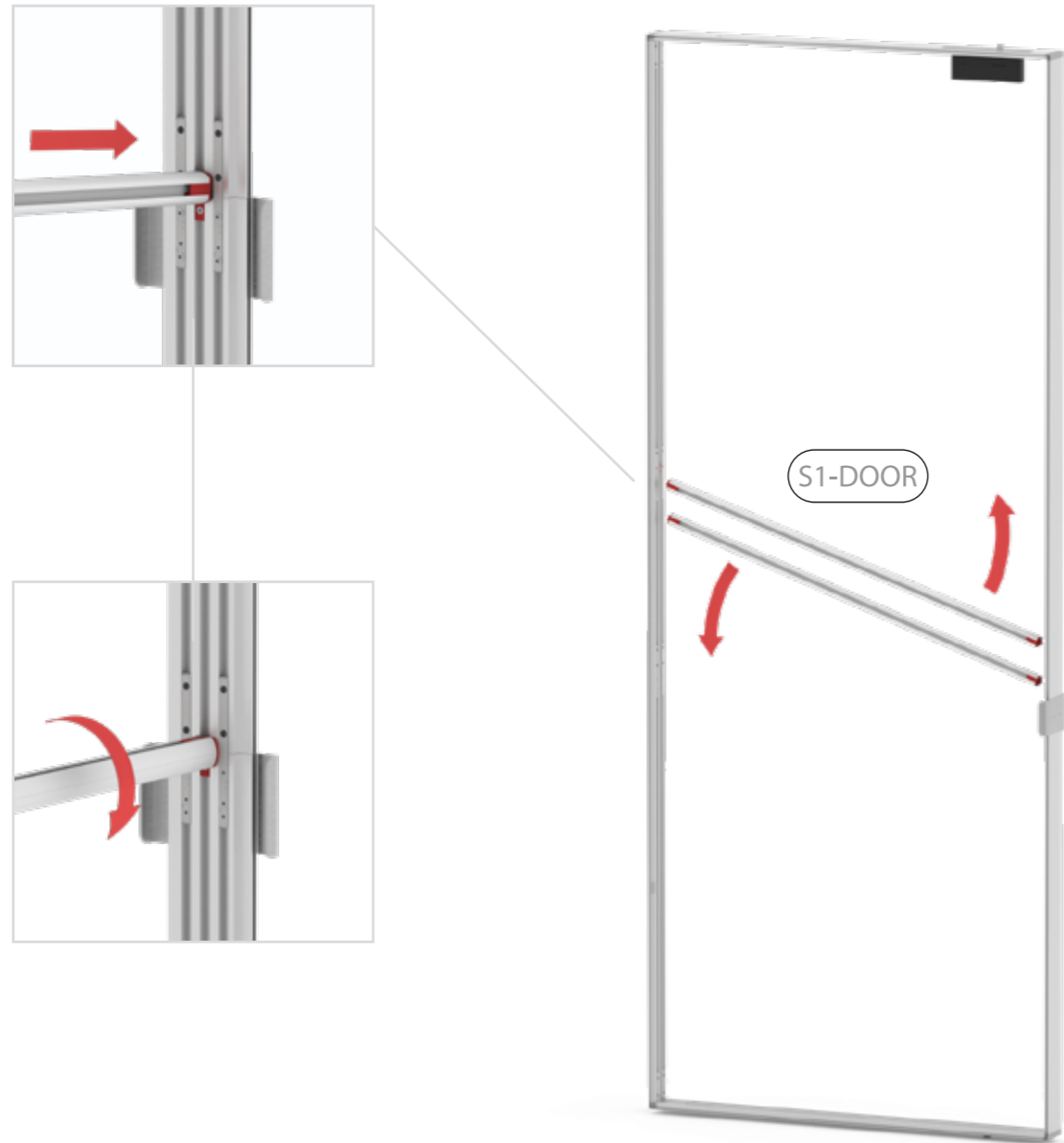

7.

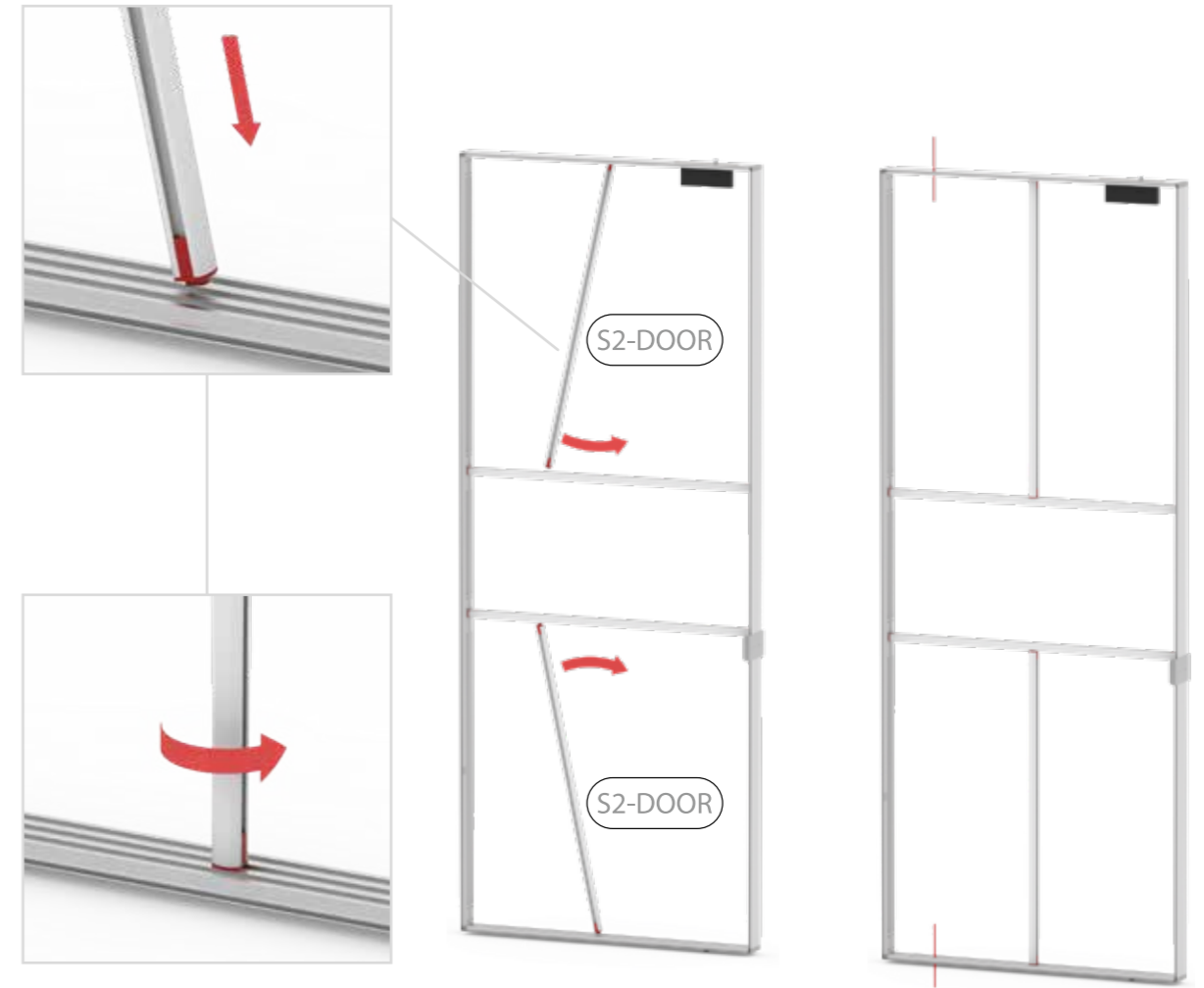

GERADE VERSION/STRAIGHT VERSION

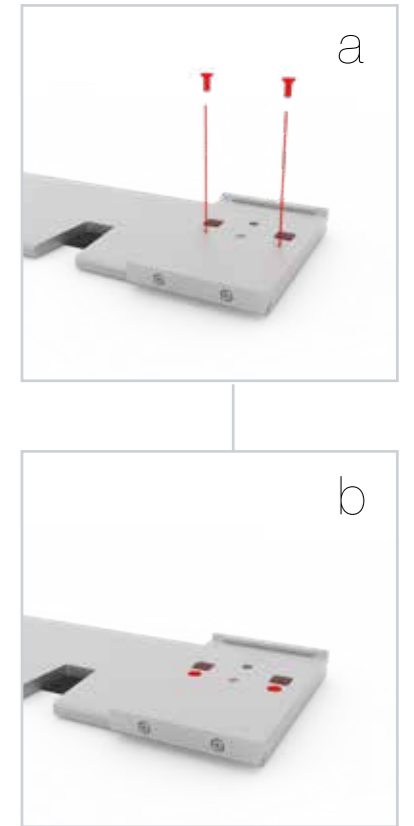
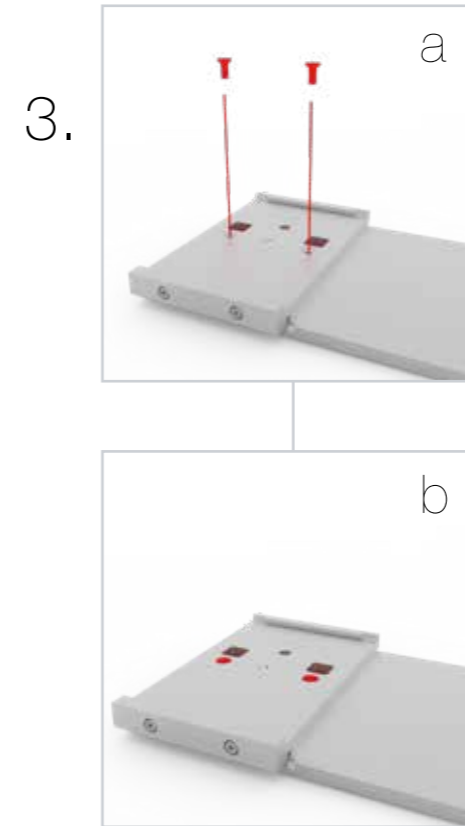
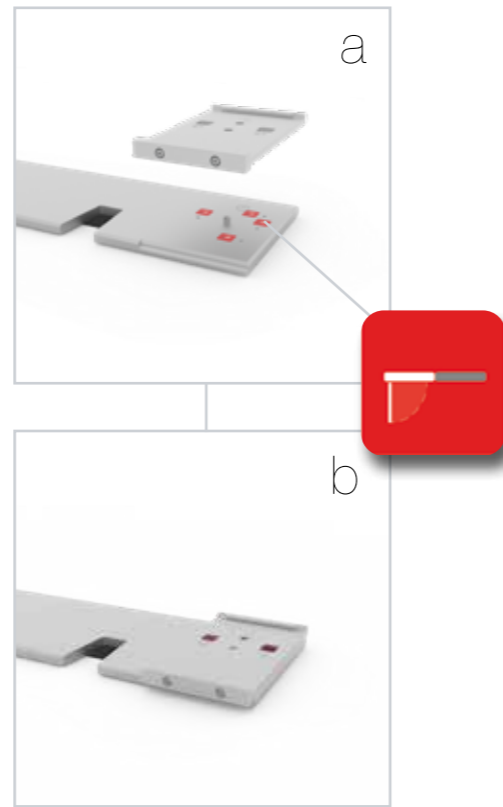
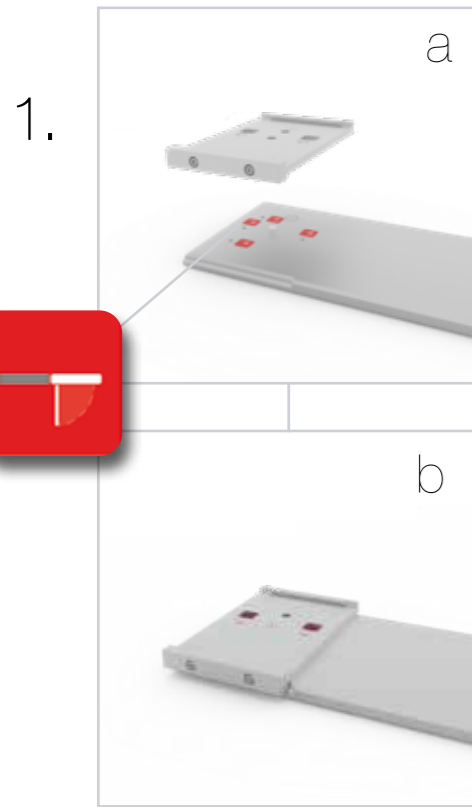

GERADE VERSION/STRAIGHT VERSION

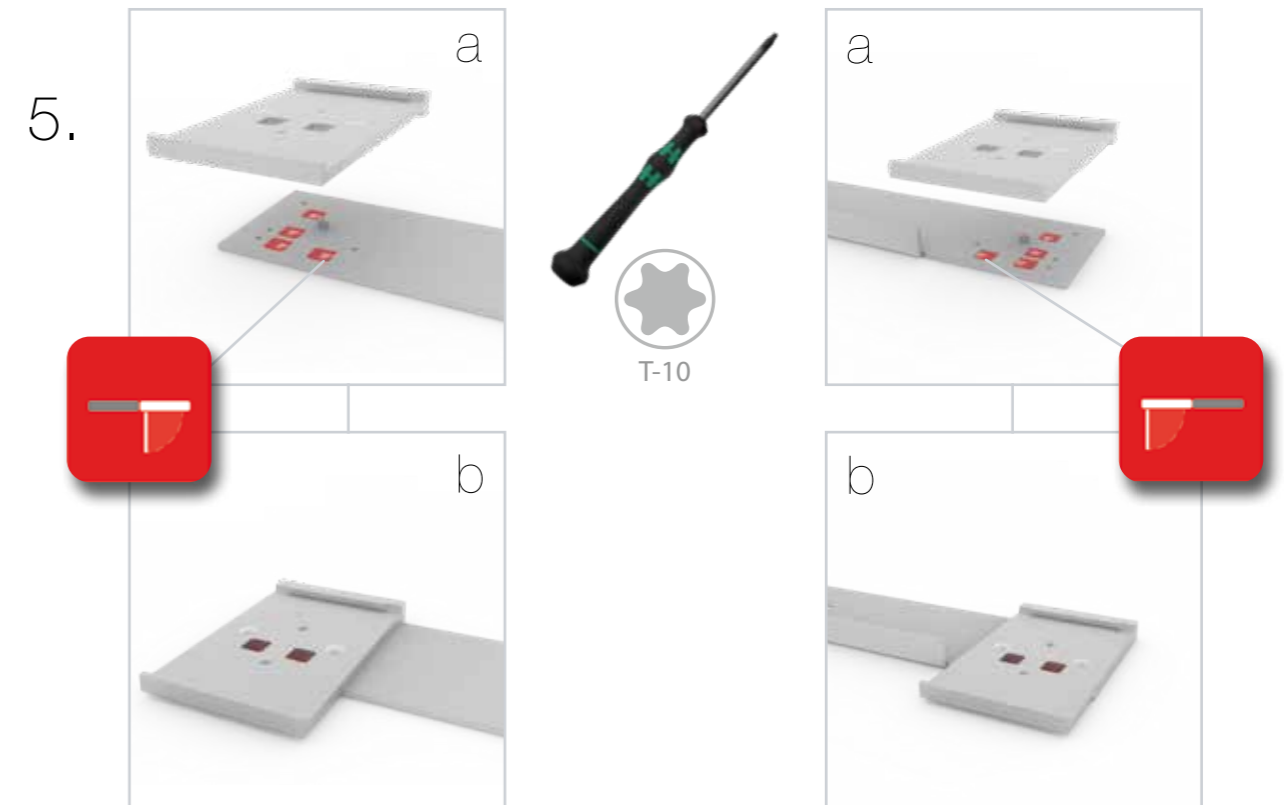
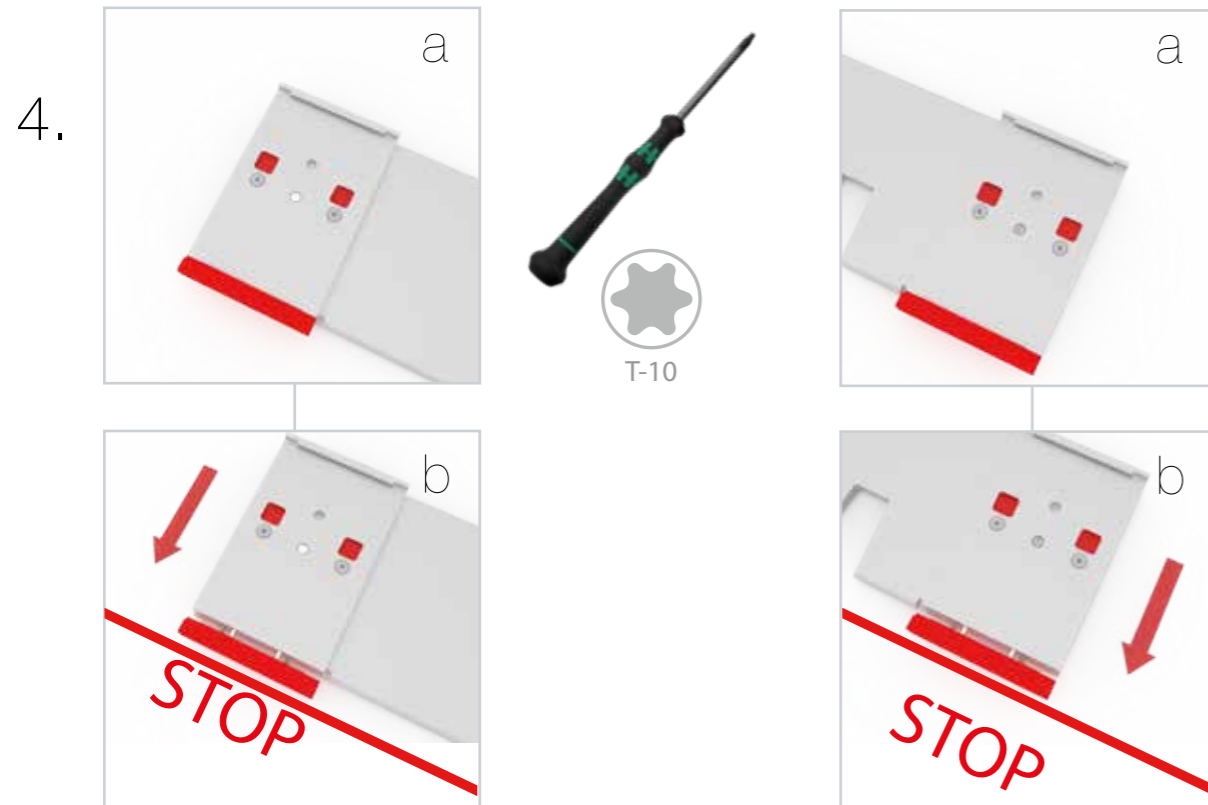

GERADE VERSION/STRAIGHT VERSION

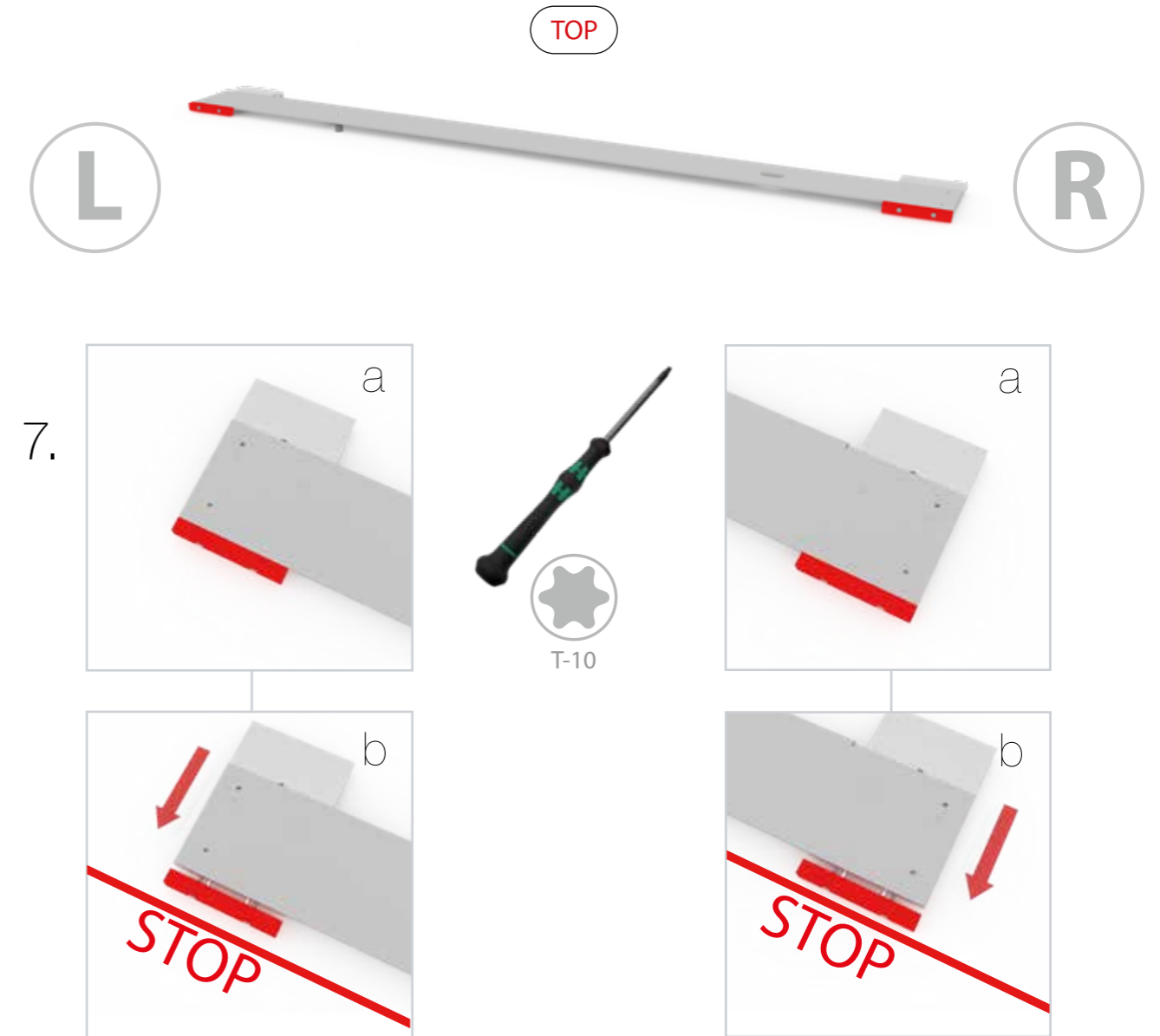
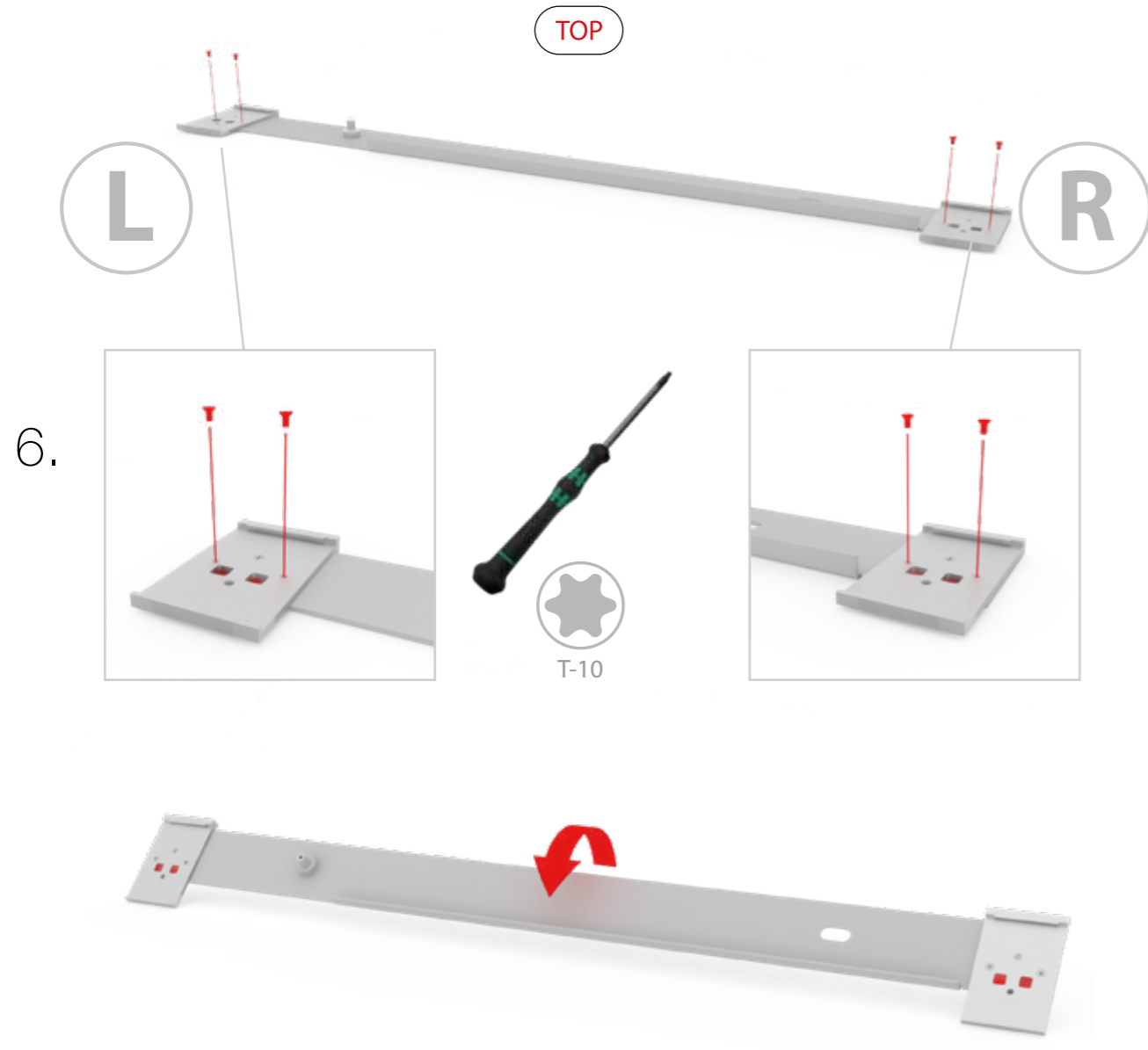

GERADE VERSION/STRAIGHT VERSION

8.

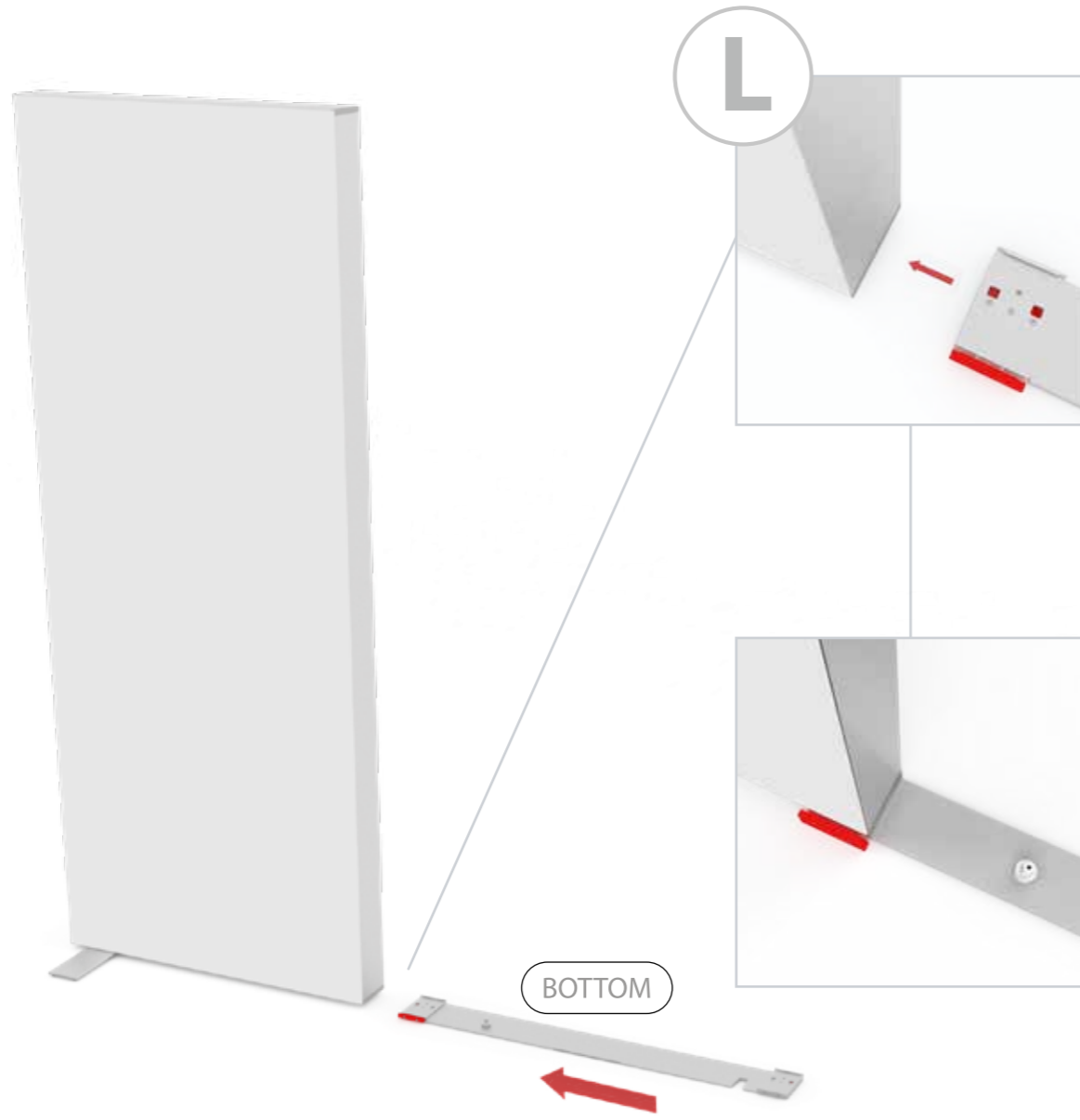

9.

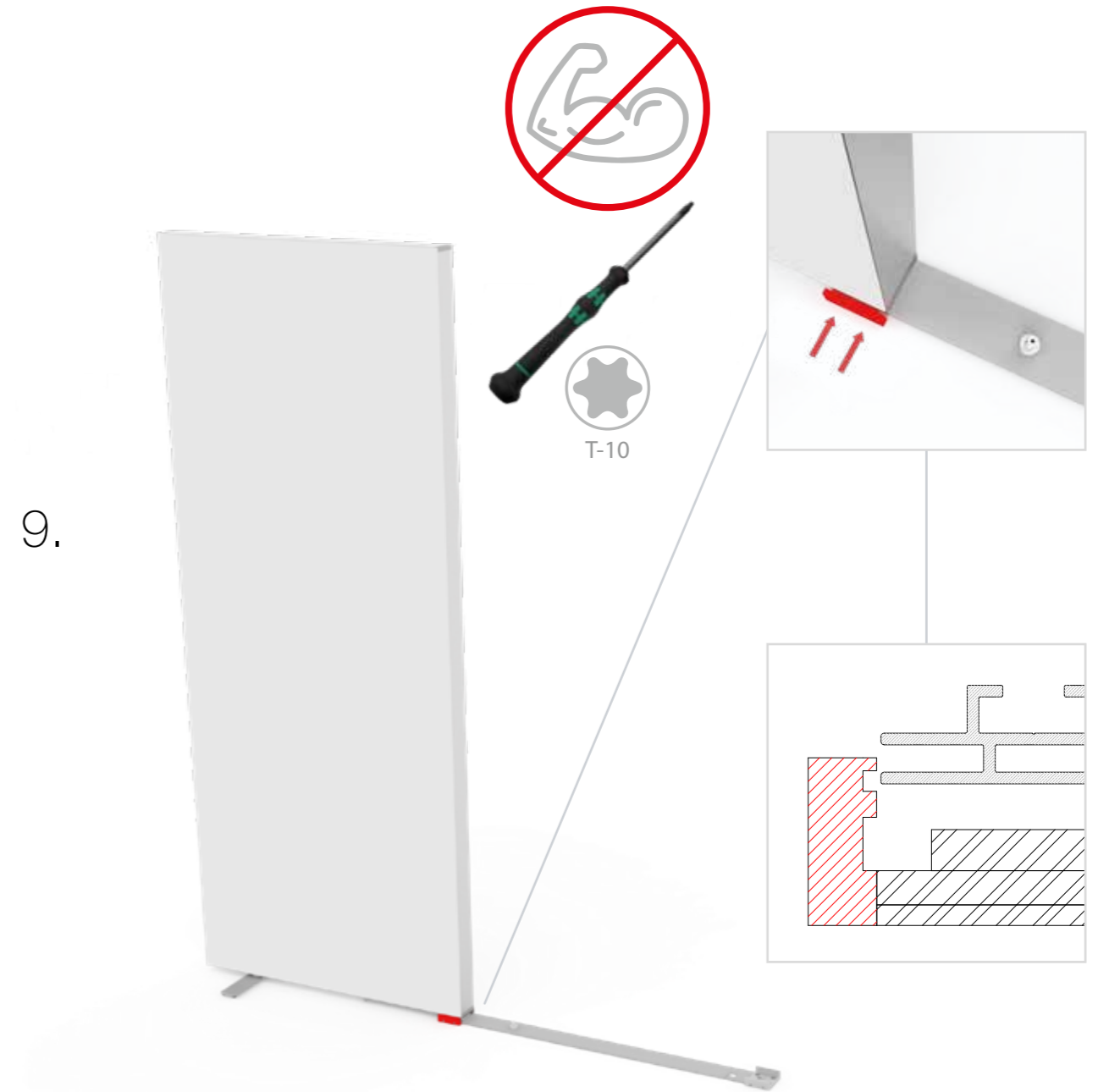

GERADE VERSION/STRAIGHT VERSION

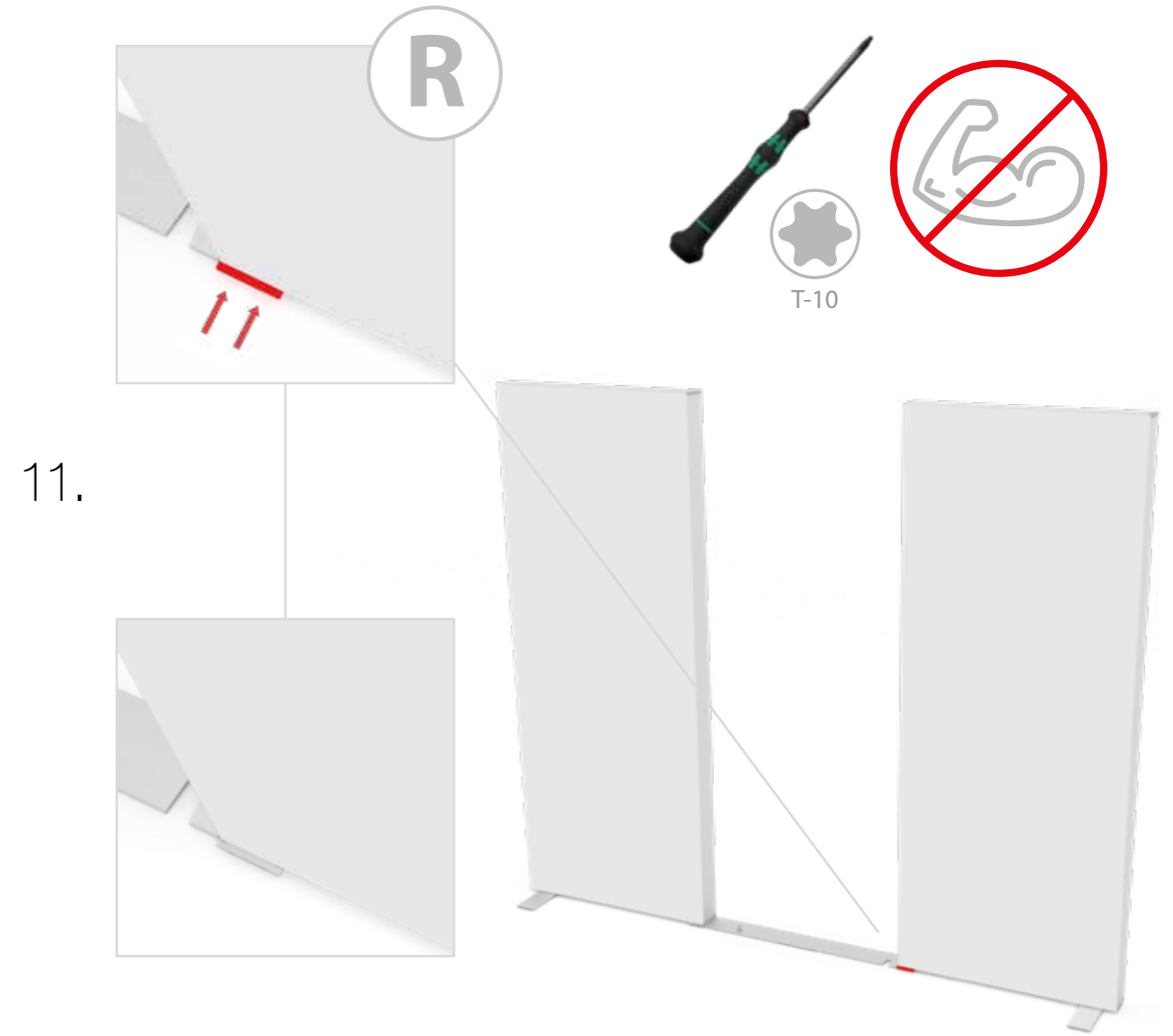
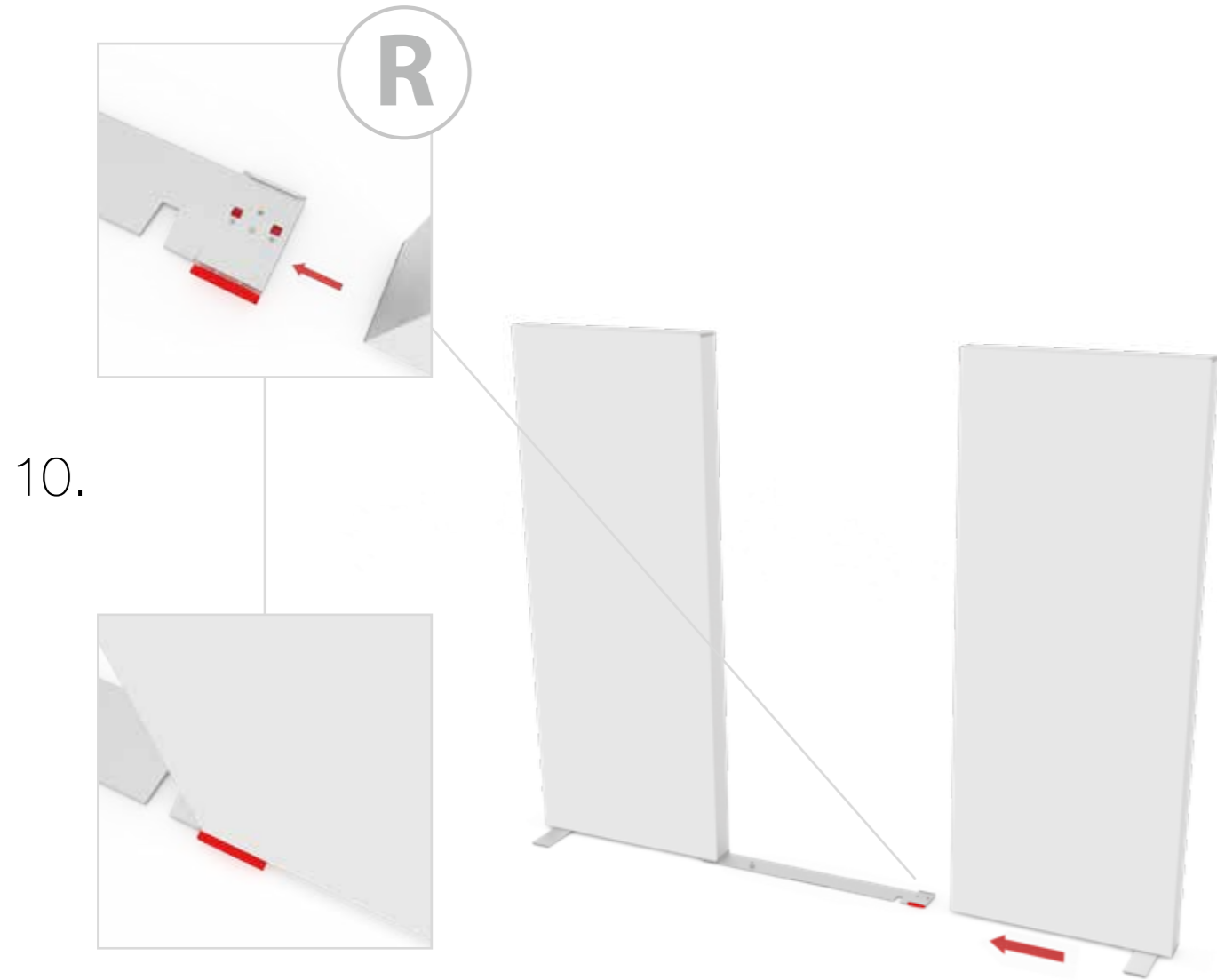

GERADE VERSION/STRAIGHT VERSION

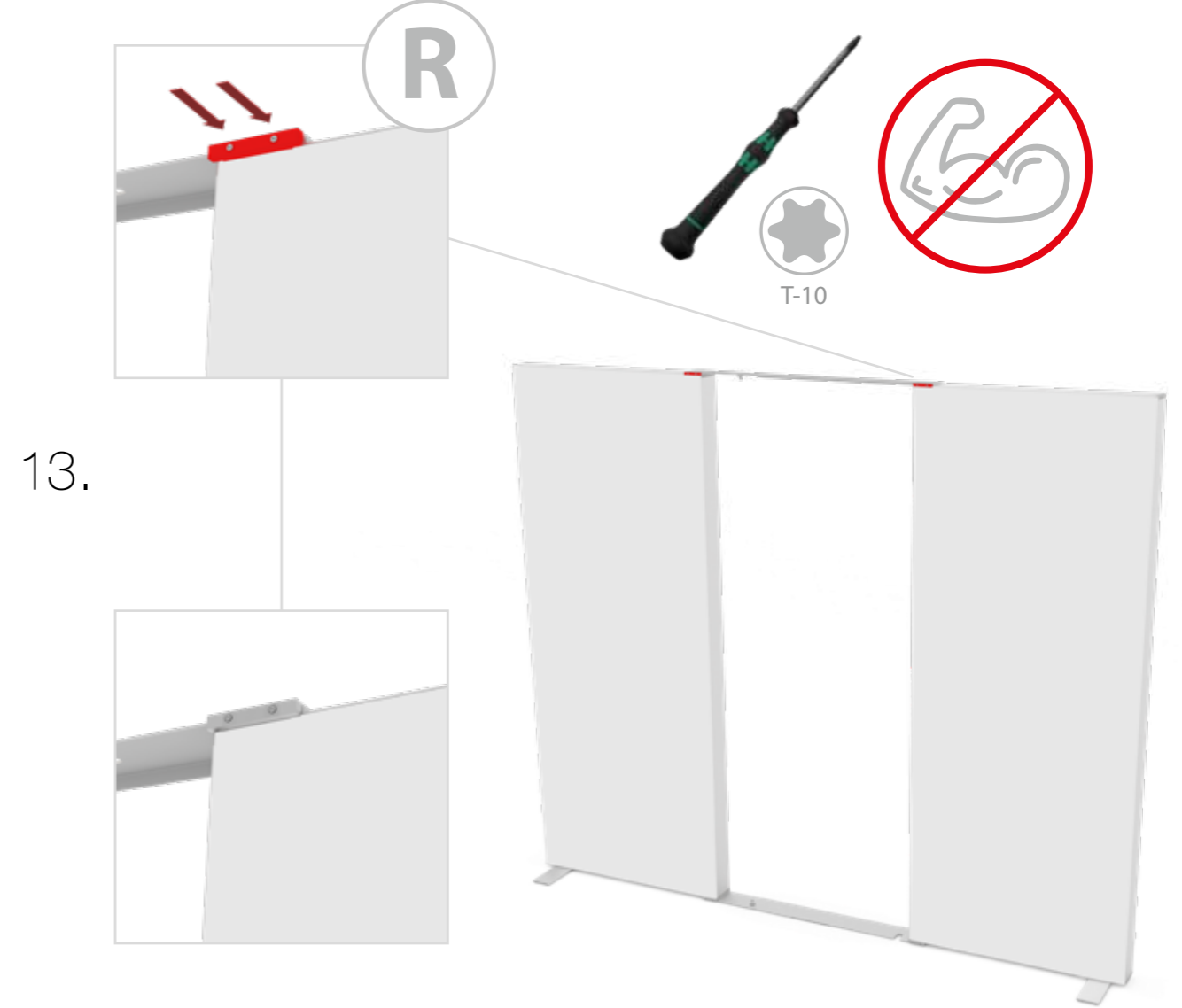
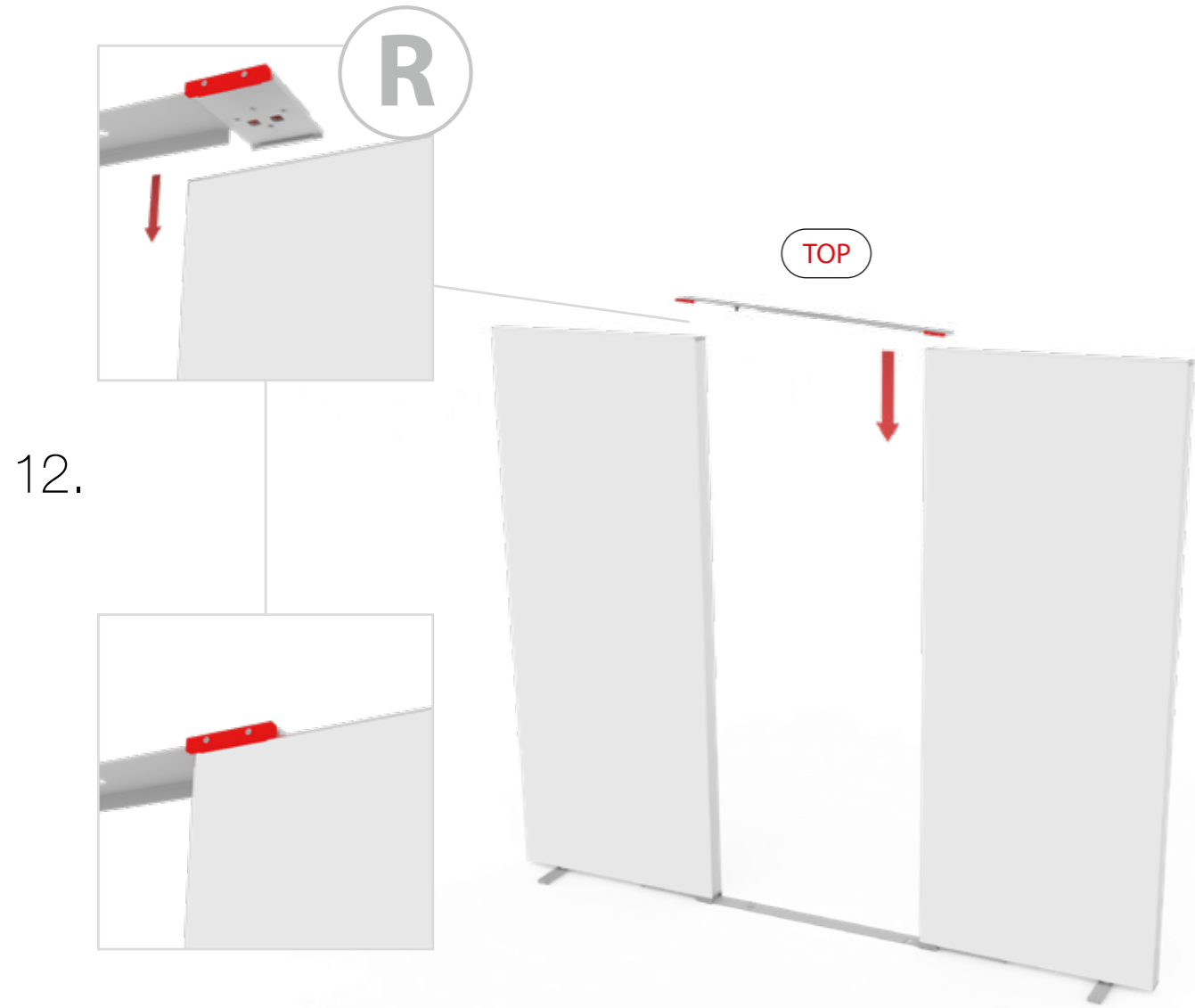

GERADE VERSION/STRAIGHT VERSION

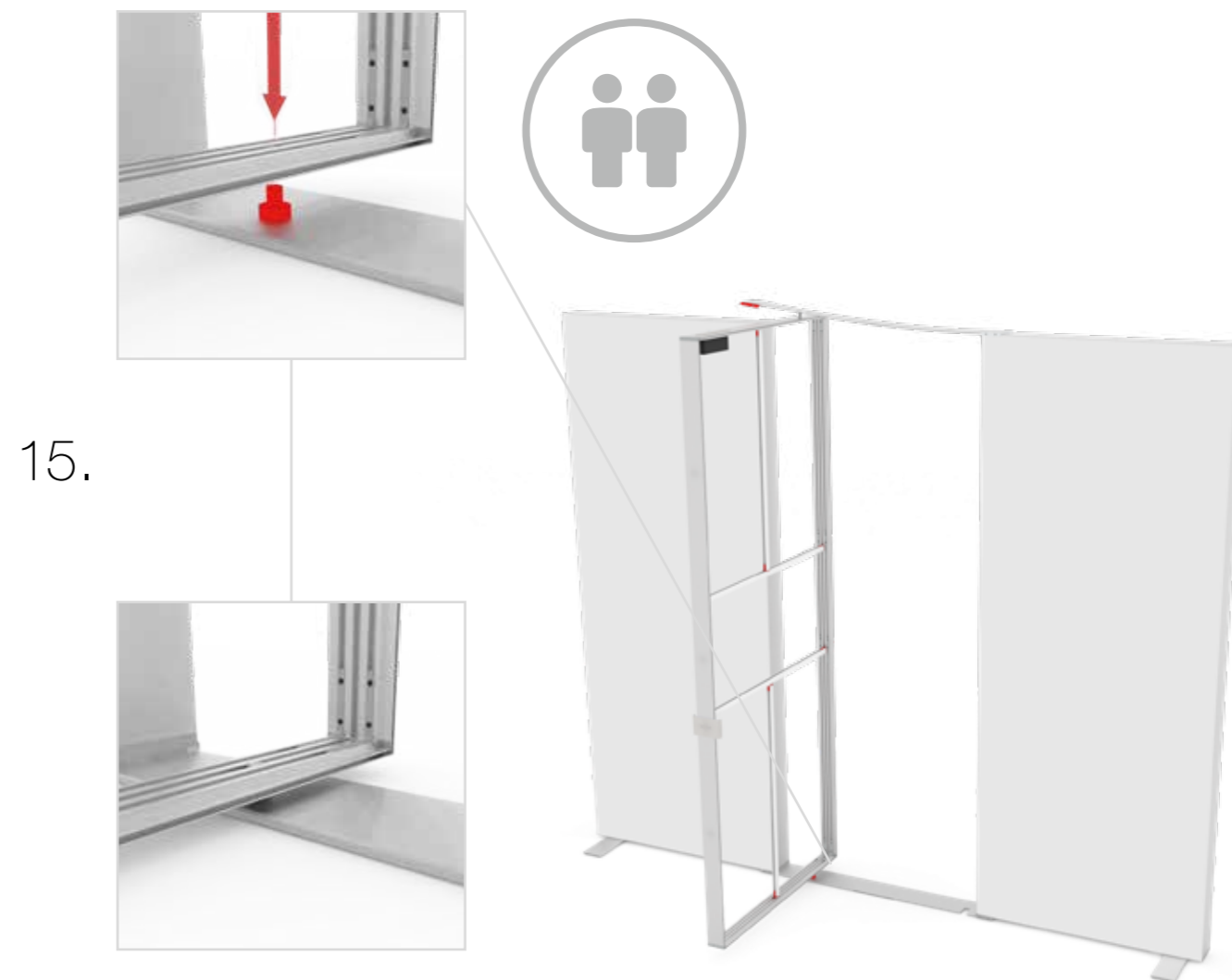
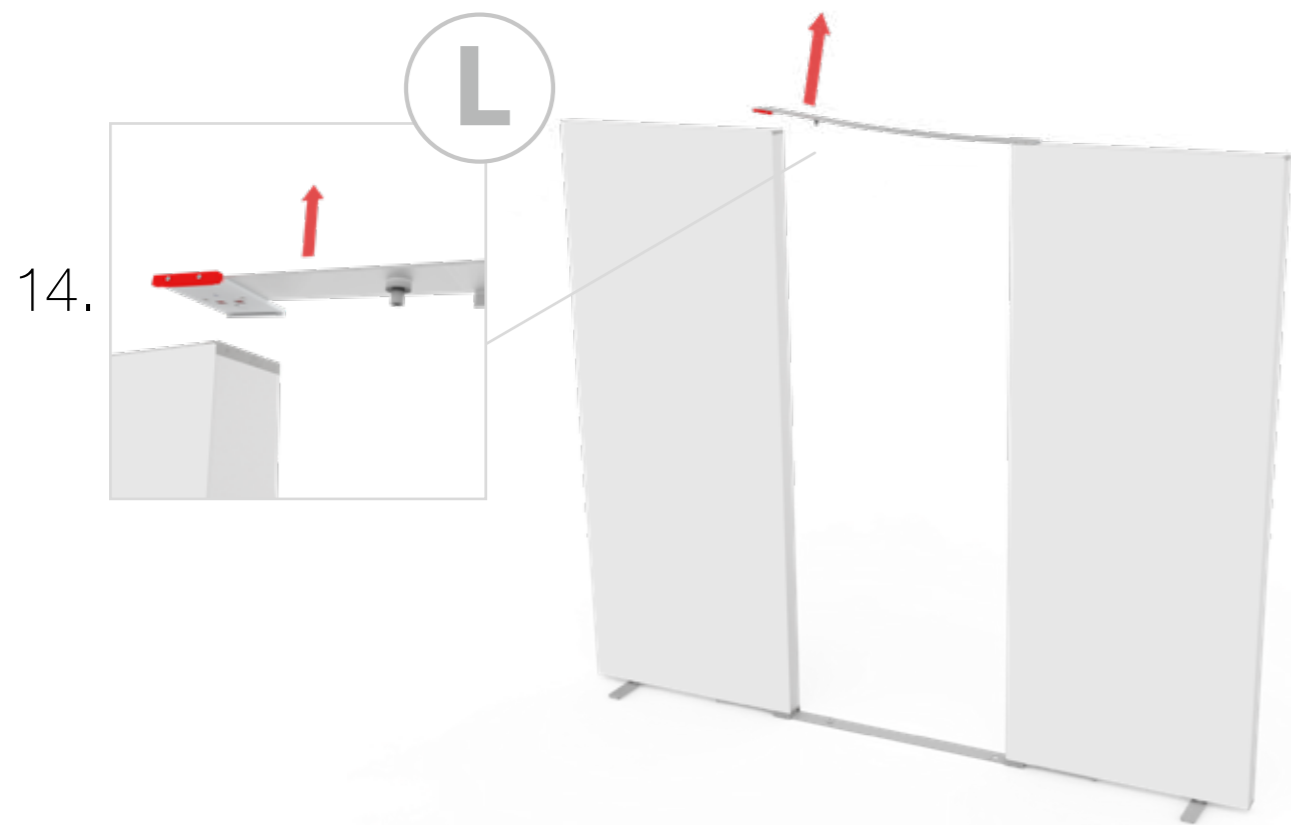

GERADE VERSION/STRAIGHT VERSION

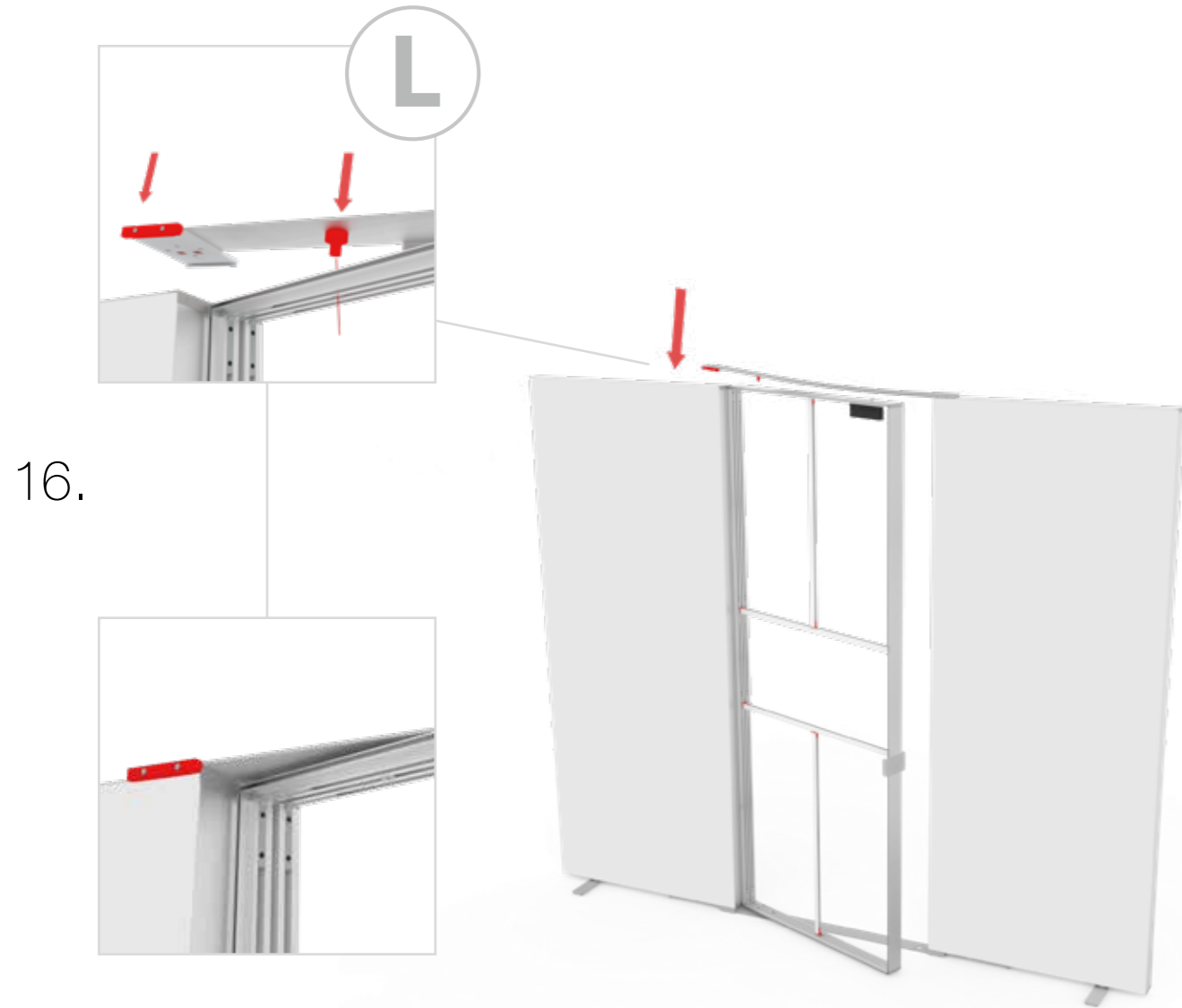

GERADE VERSION/STRAIGHT VERSION

GERADE VERSION/STRAIGHT VERSION

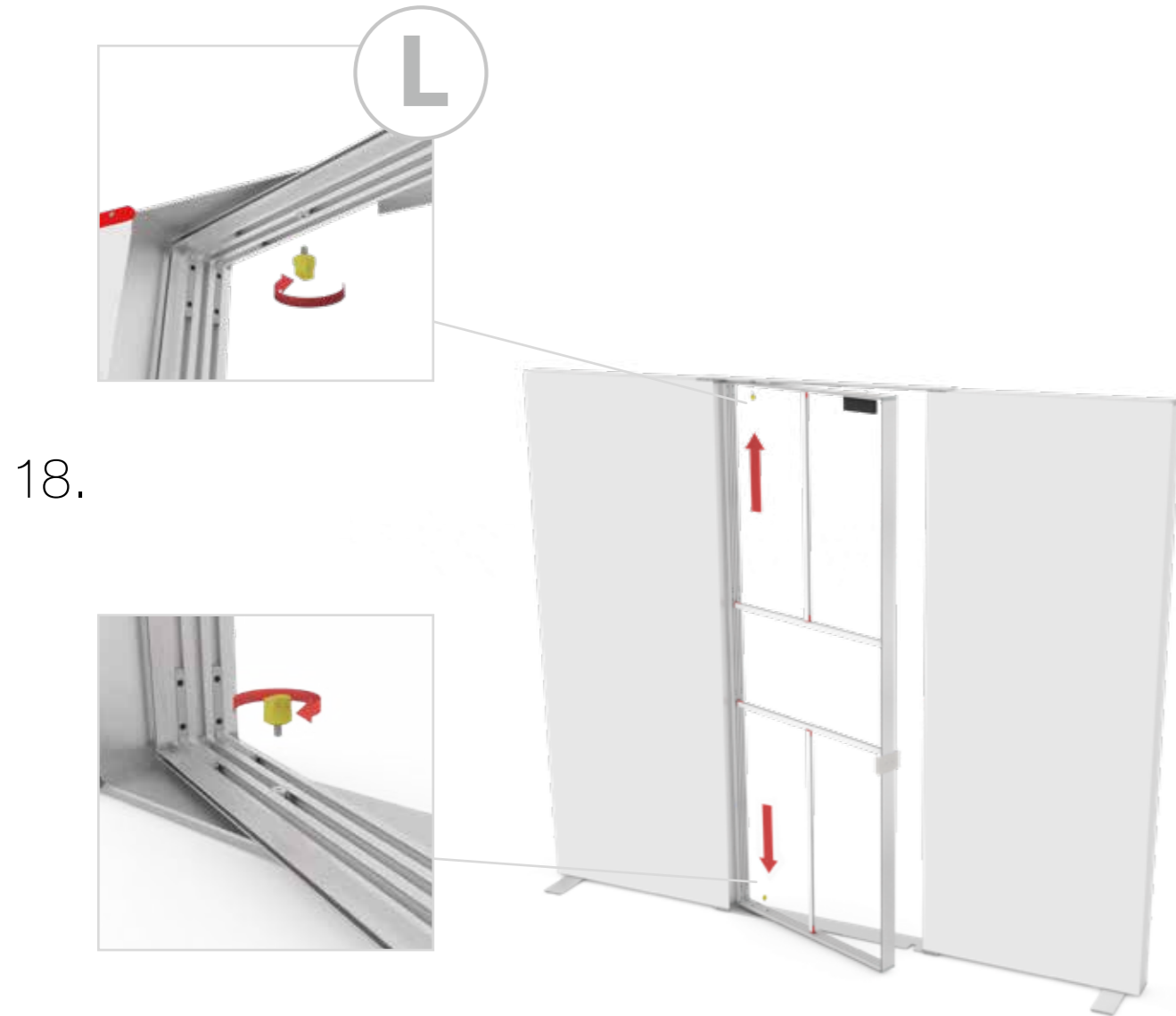

2 SEK. DRÜCKEN
PRESS FOR 2 SEC.

ECK- & KOJENVERSION/CORNER & STORAGE VERSION

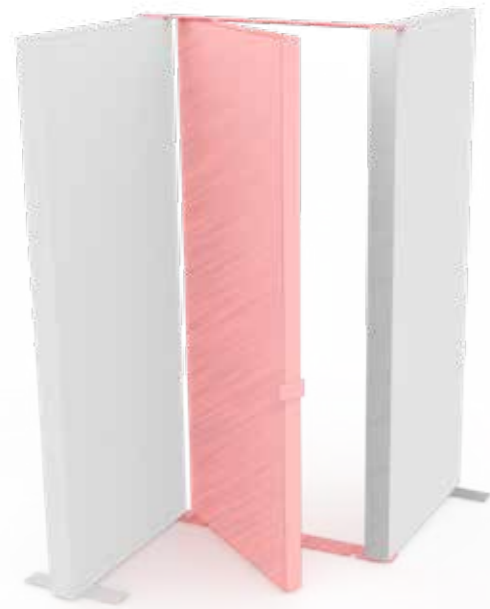

corner-L



corner-R



storage room

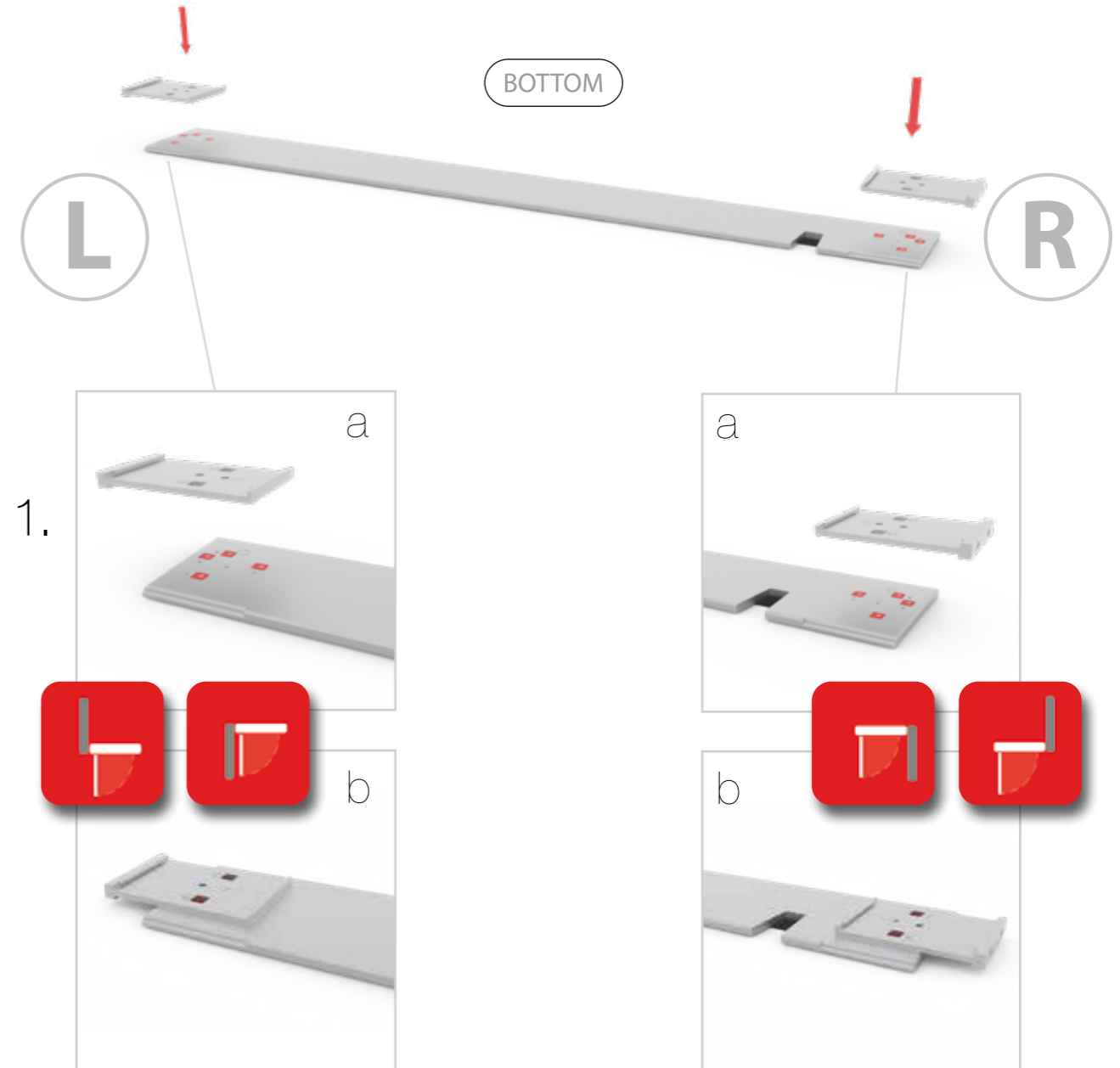

ECK- & KOJENVERSION/CORNER & STORAGE VERSION

