

AUFBAUANLEITUNG SET UP INSTRUCTION

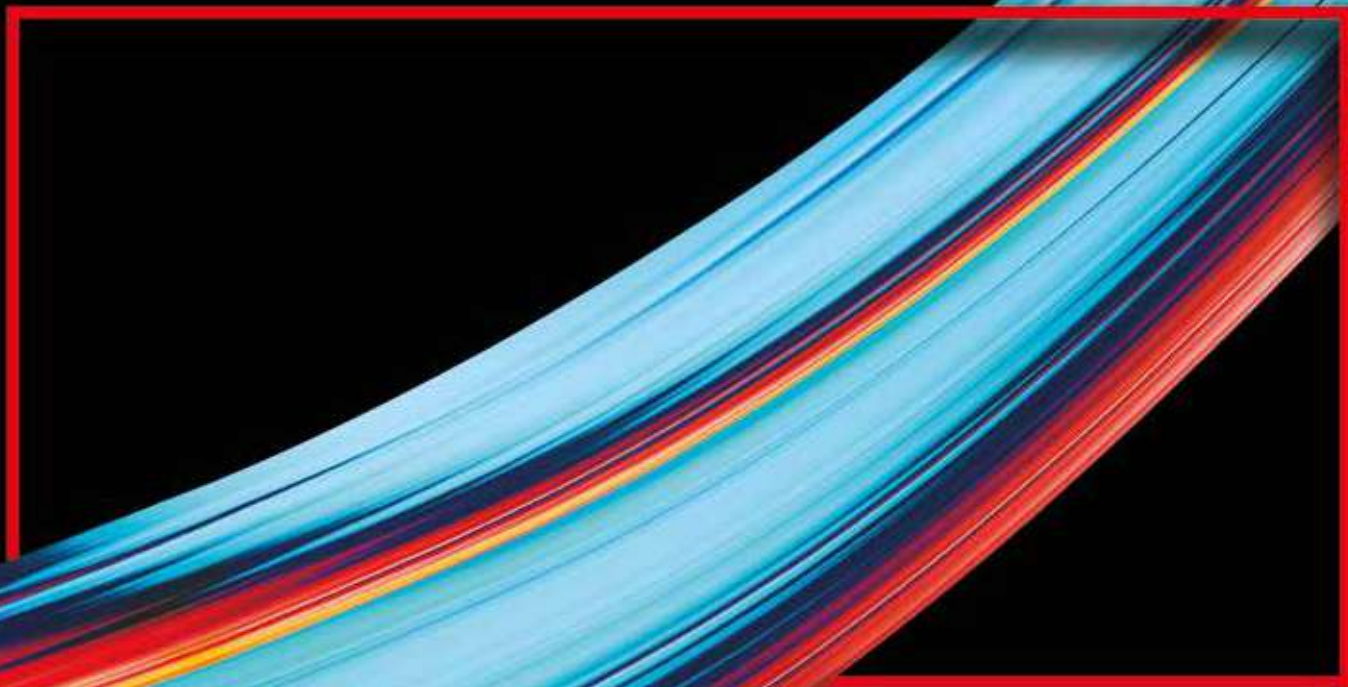

BIG LED UP

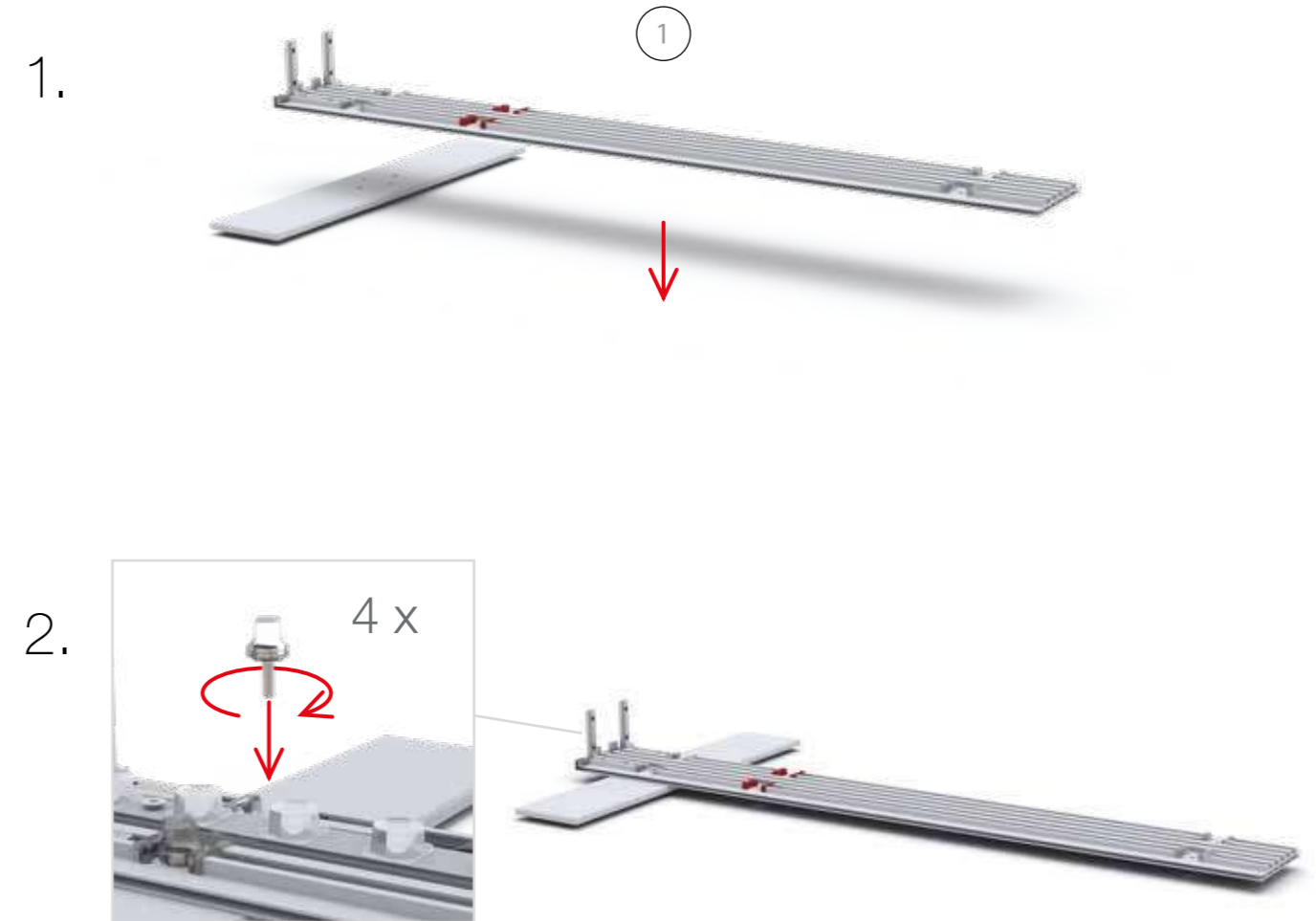

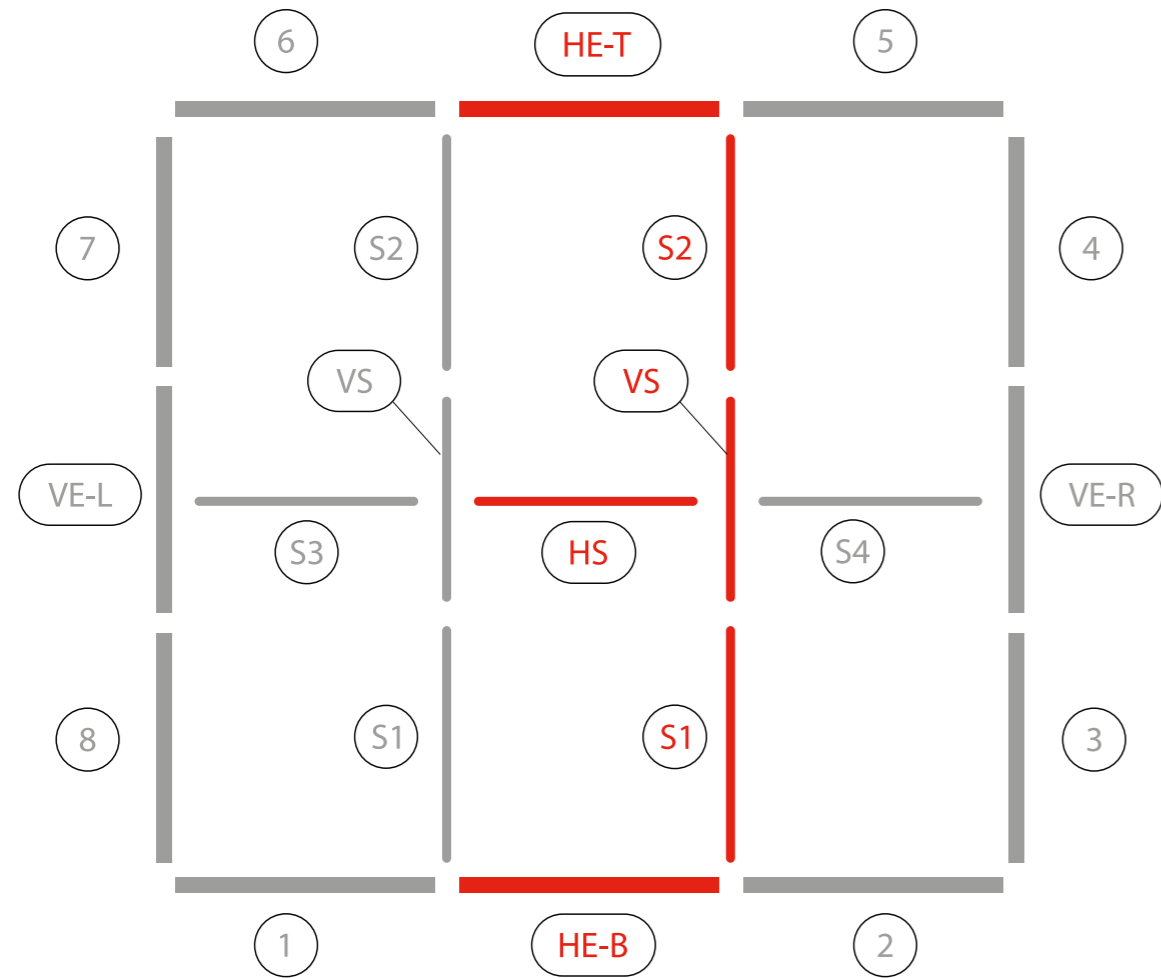
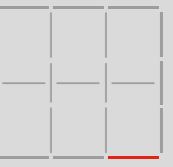
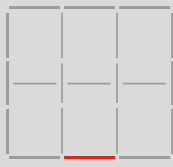

3.



5.



4.



6.



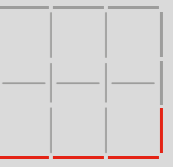
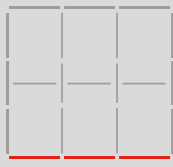

7.

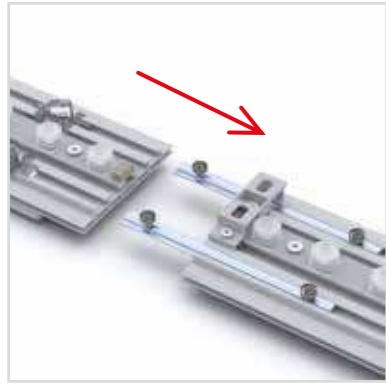

9.



8.

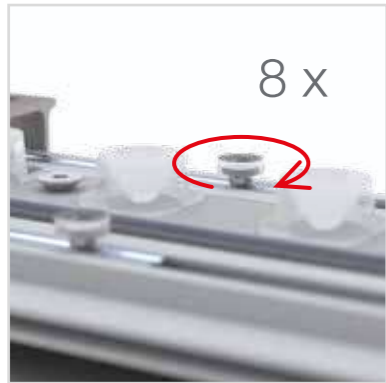

10.

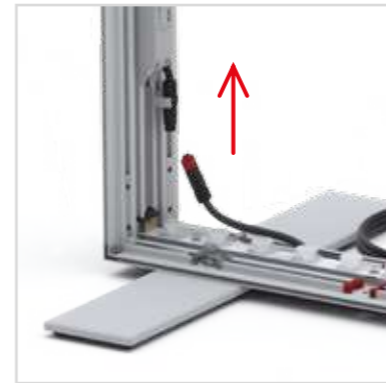

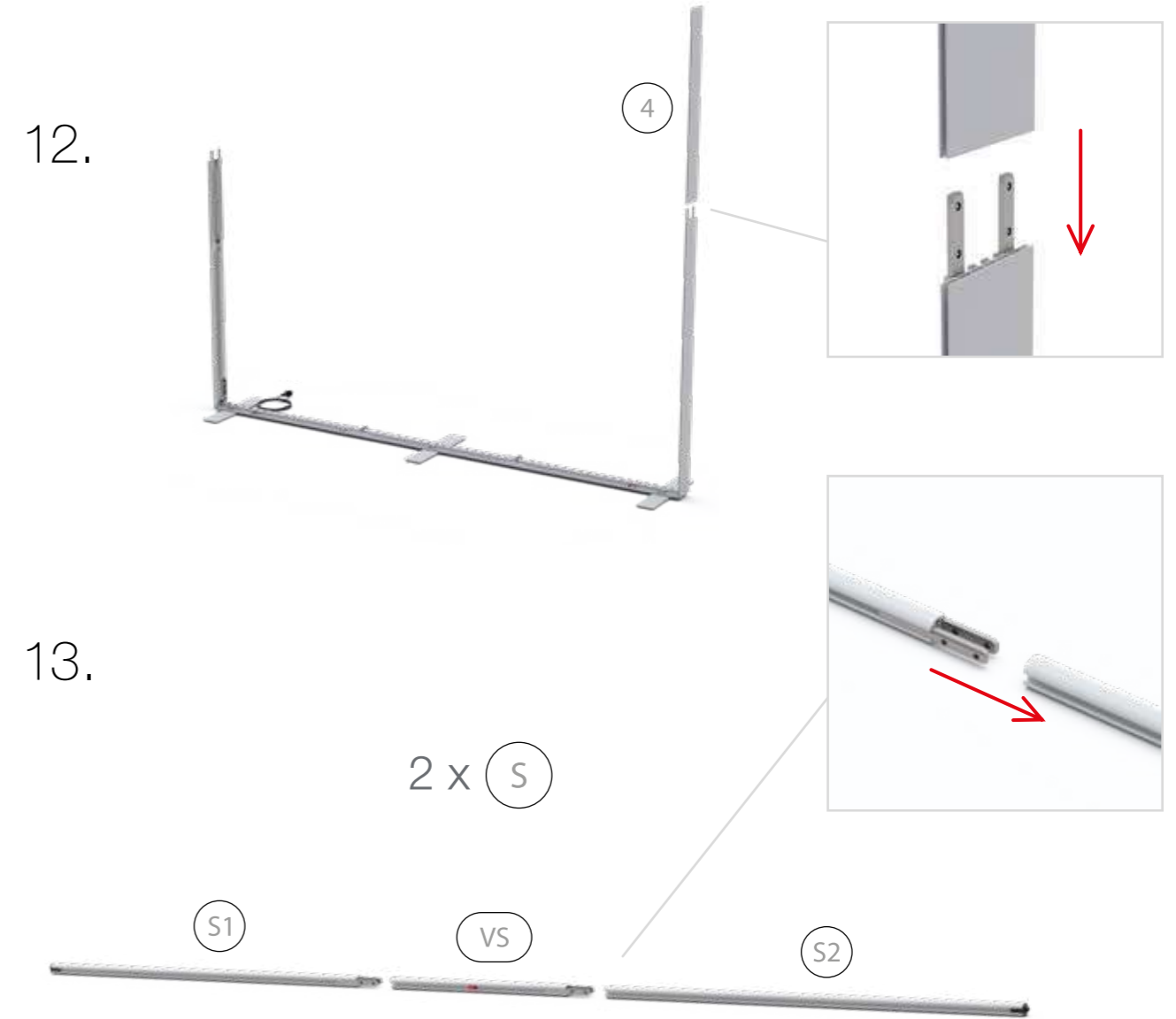
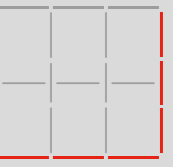
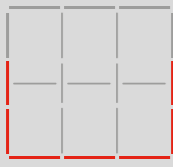

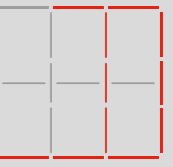
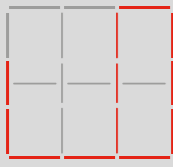

14.

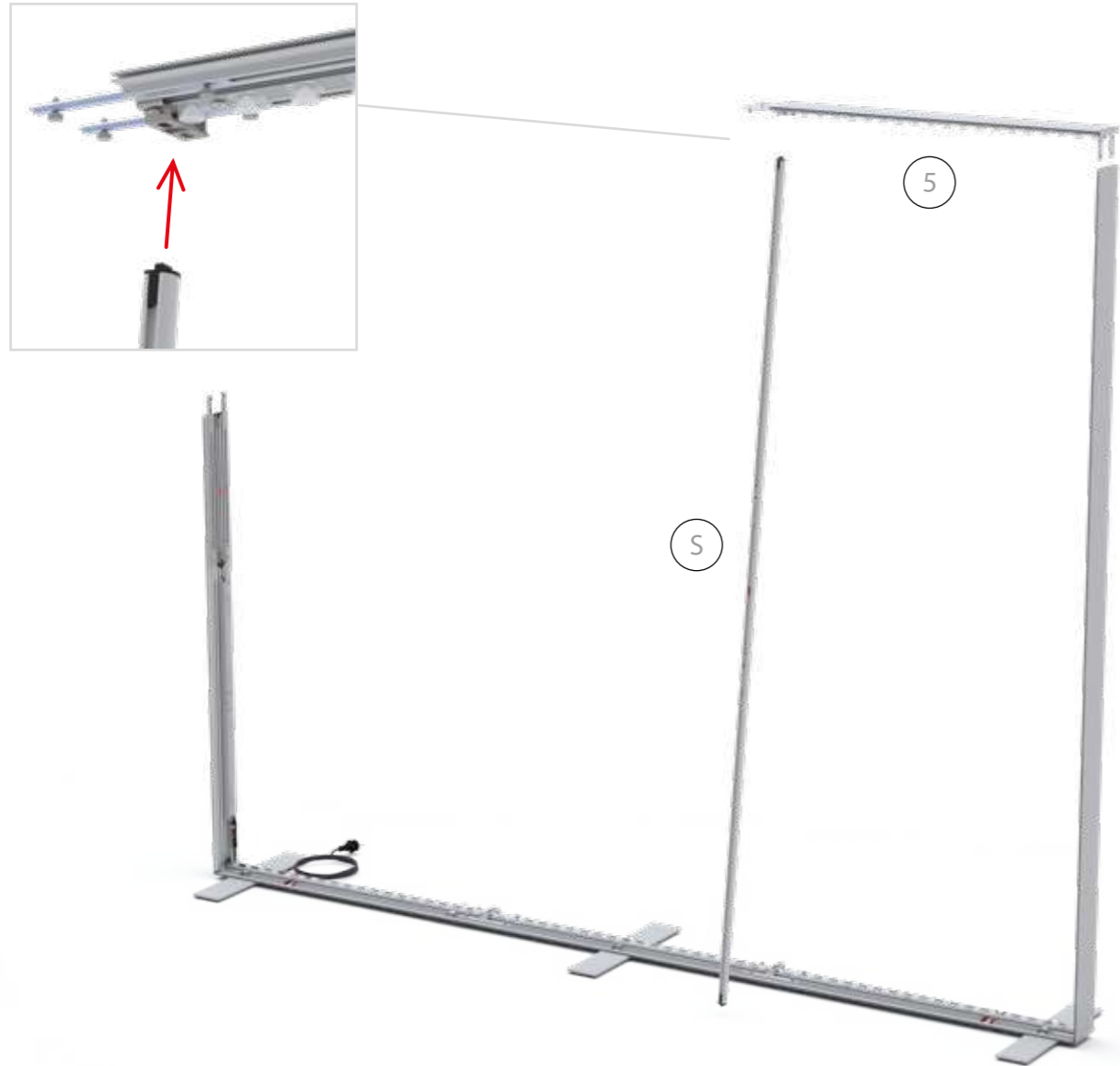

15.

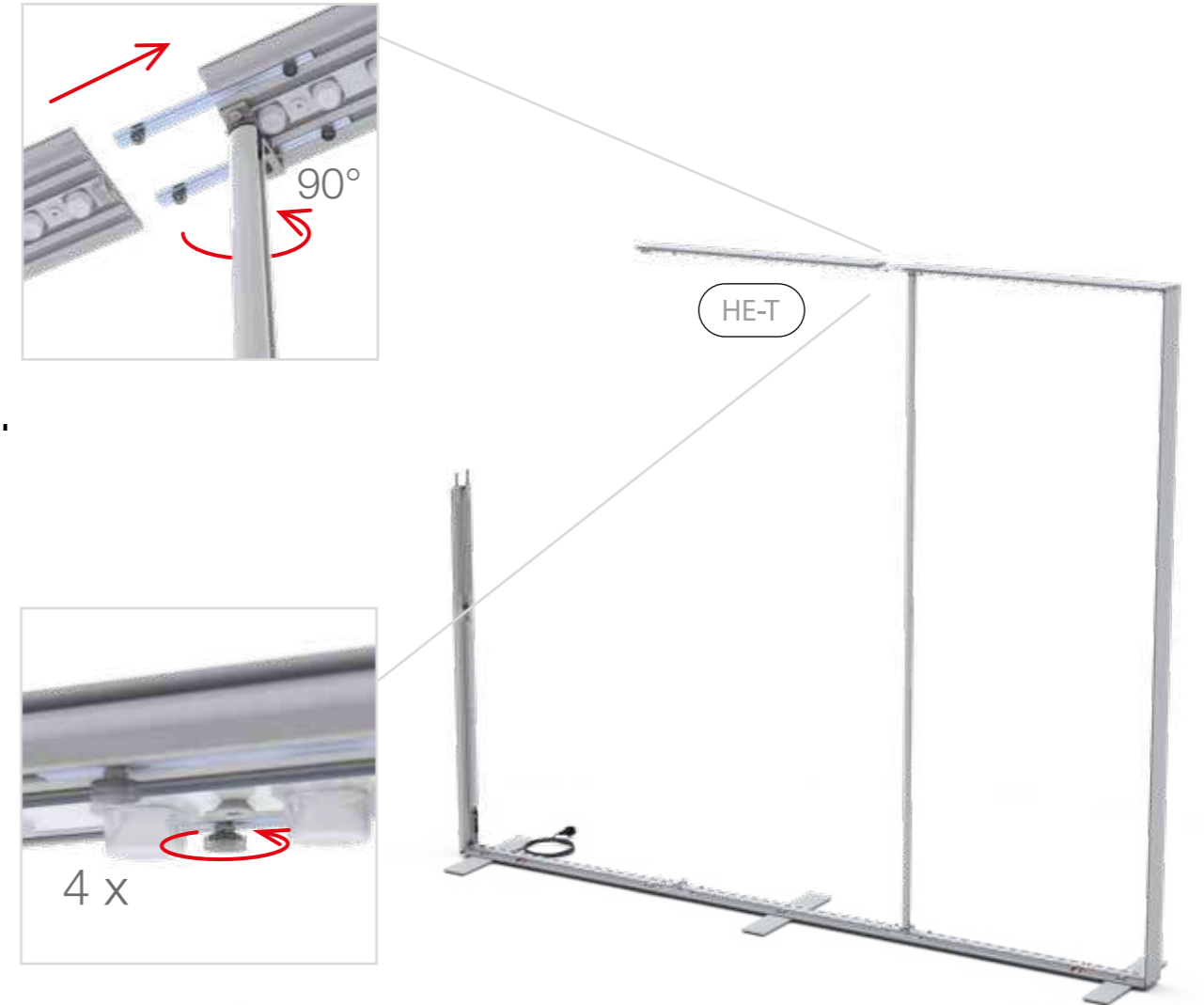

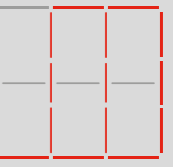
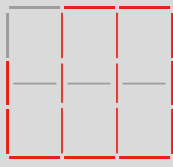

16.



17.



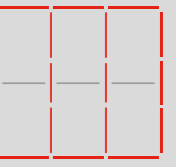
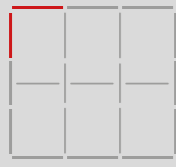

18.



19.

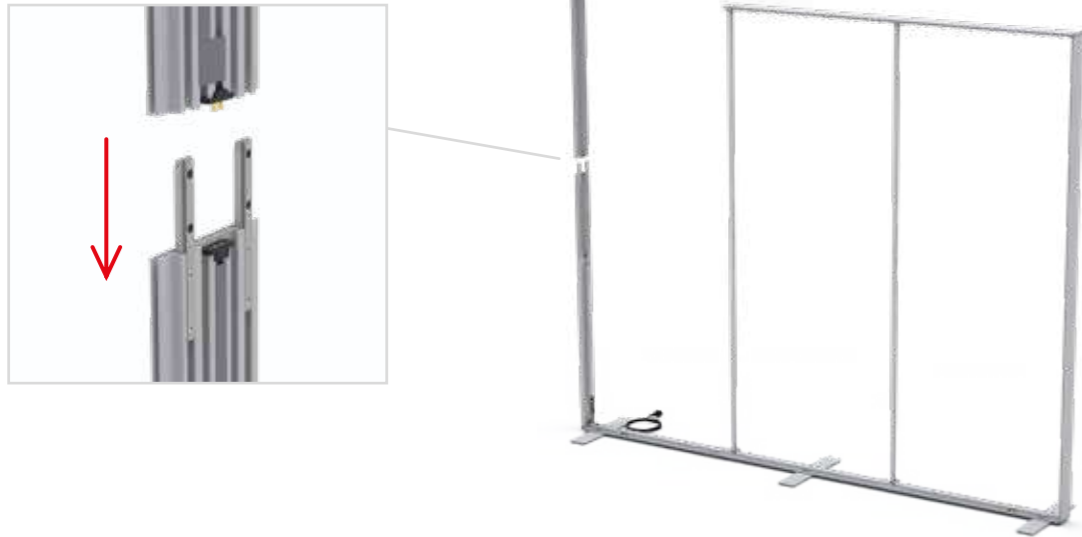

20.

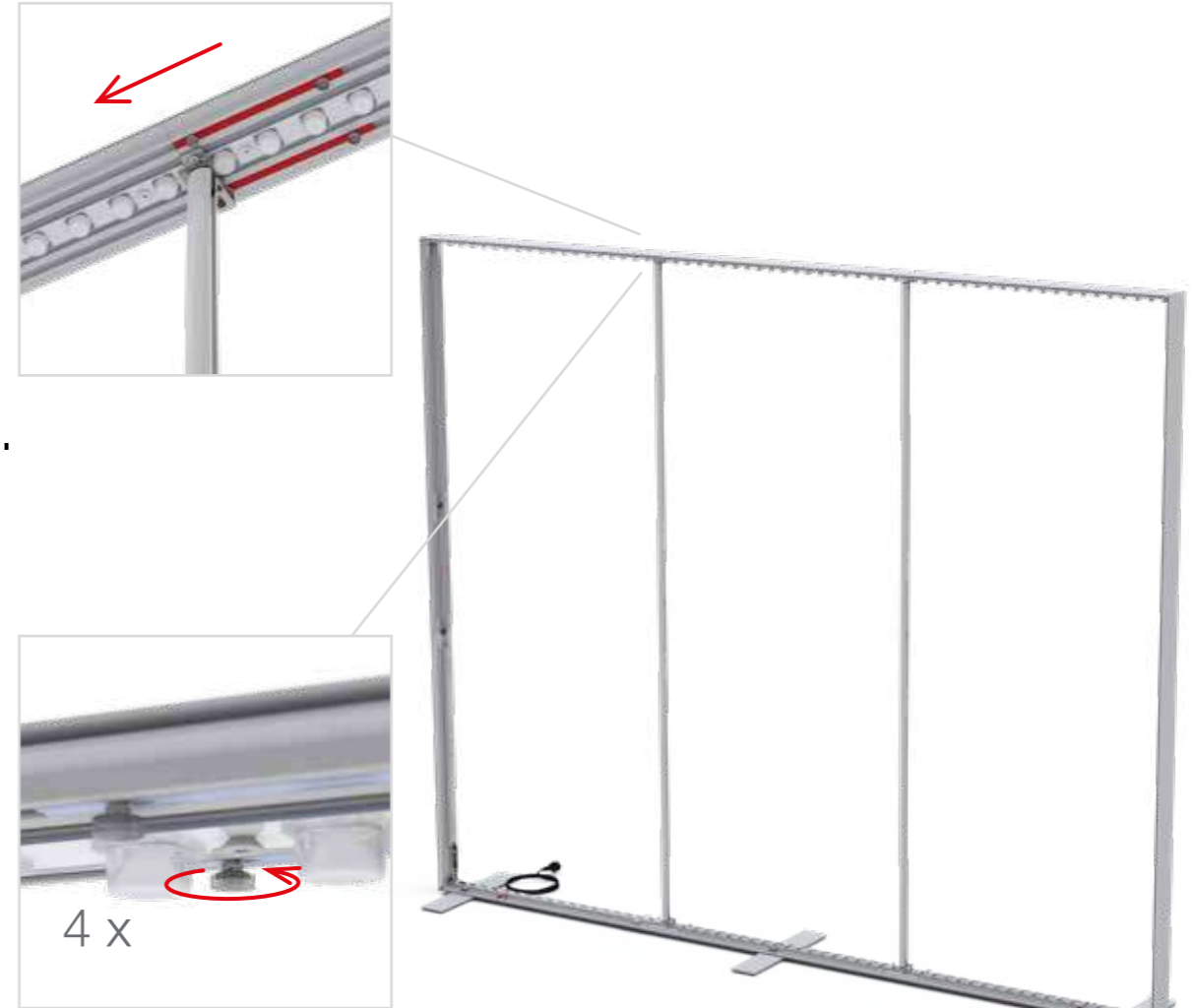

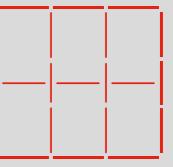
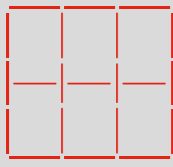

21.

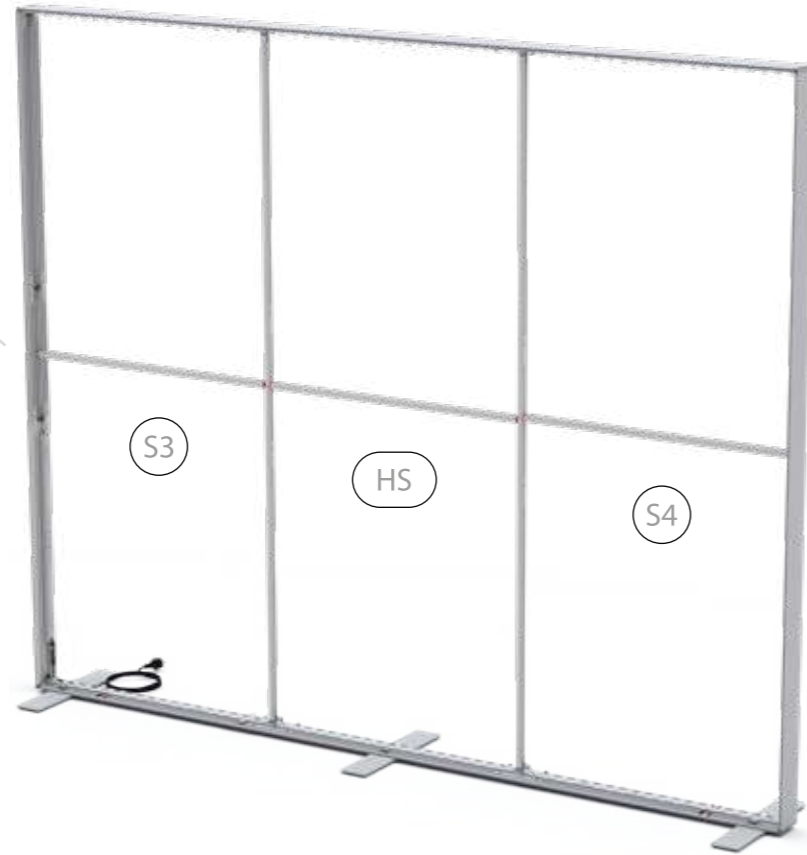
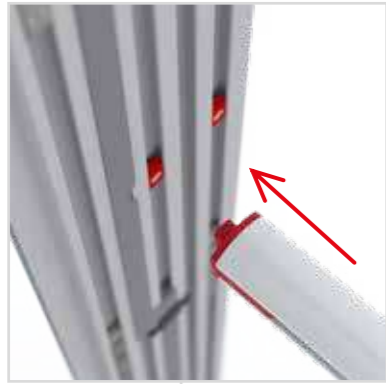

22.

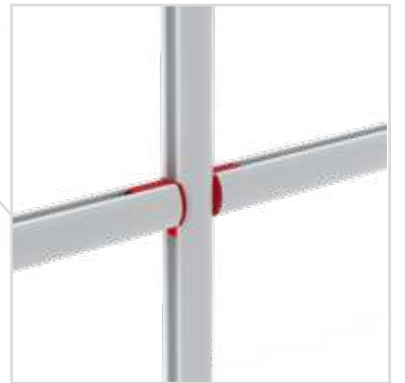

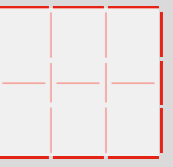
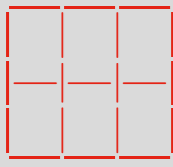

23.

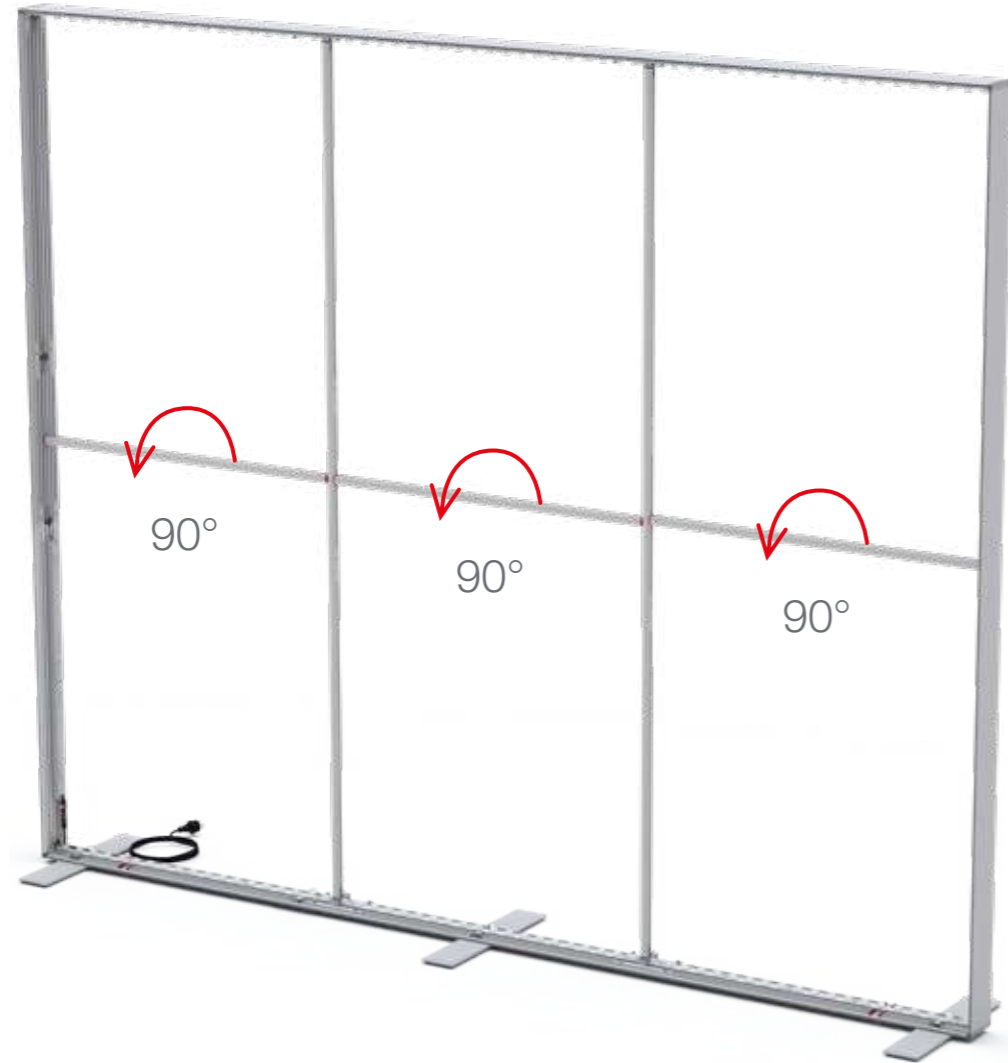

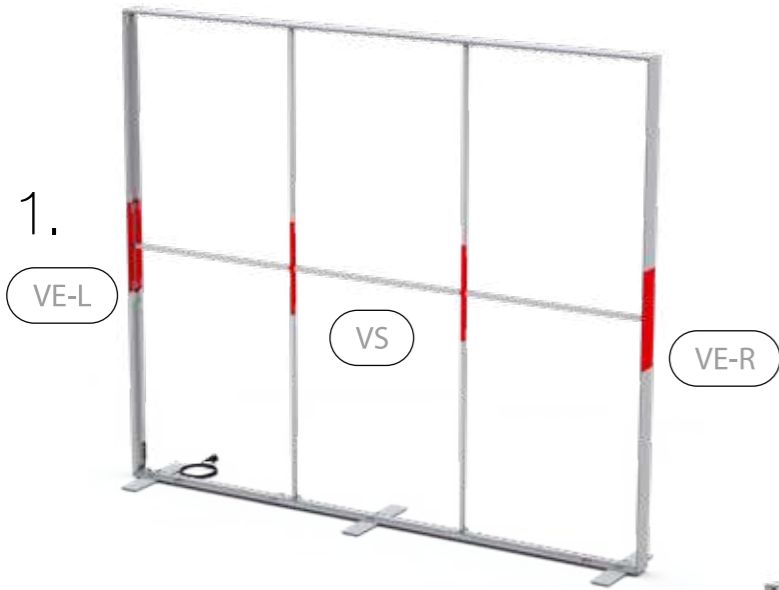

AUFBAUANLEITUNG SET UP INSTRUCTION

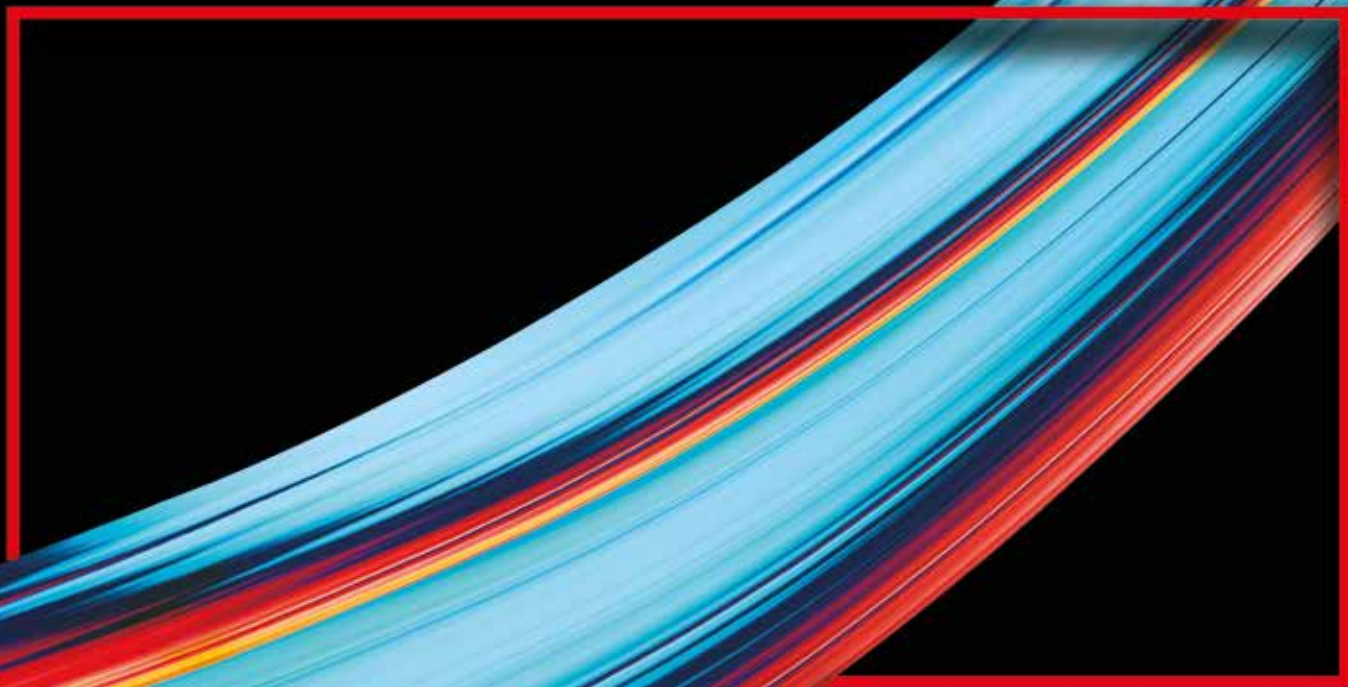

BIG LED UP

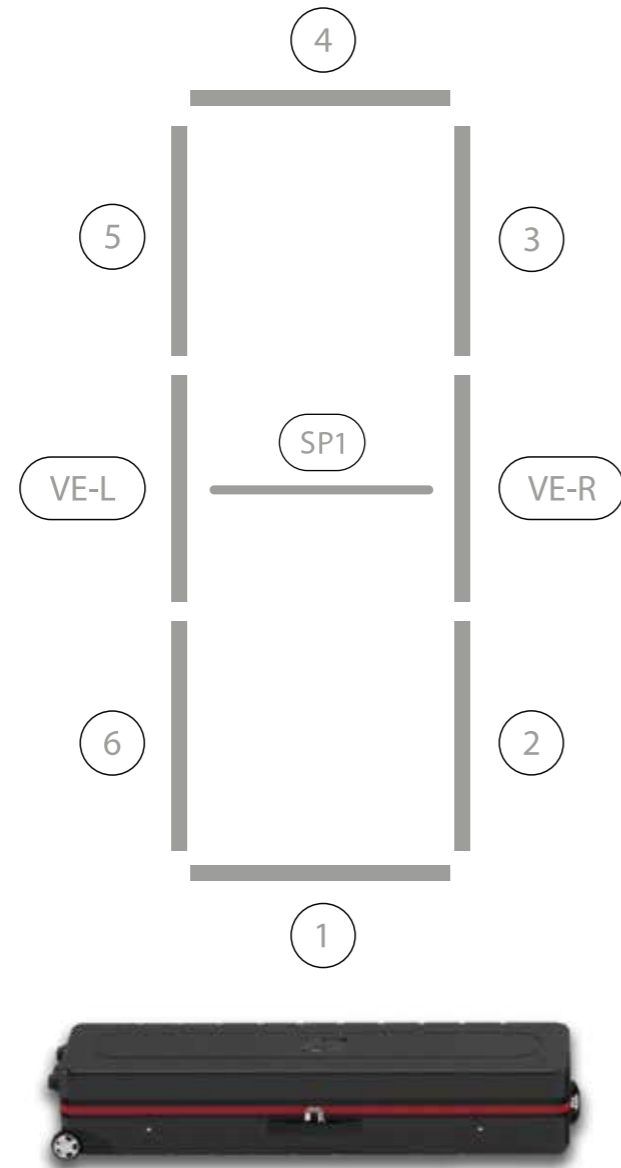

1.

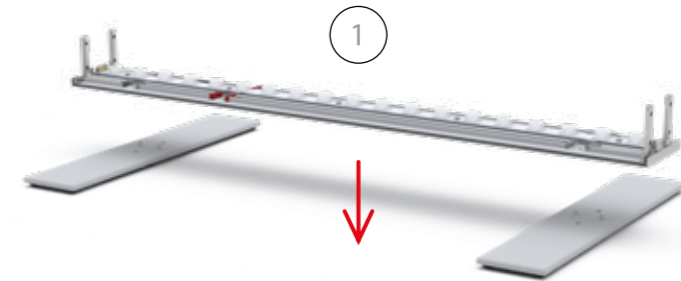

2.

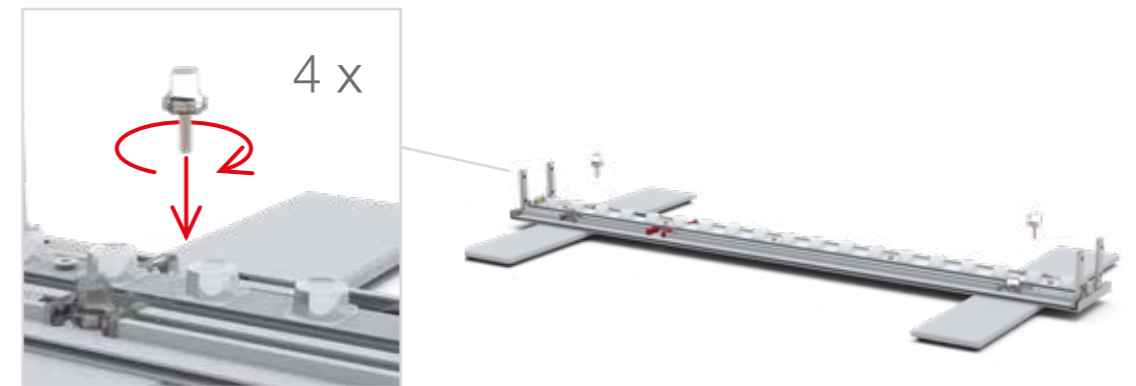



3.

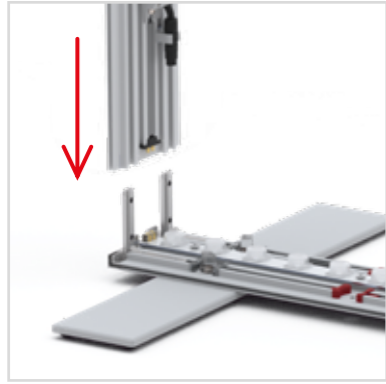

4.

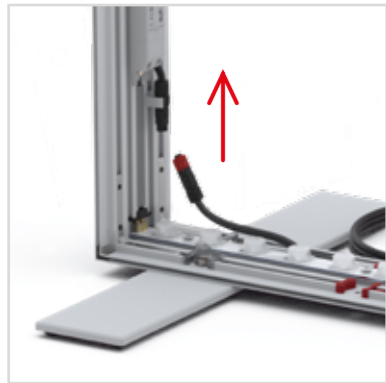

5.





6.



7.





8.

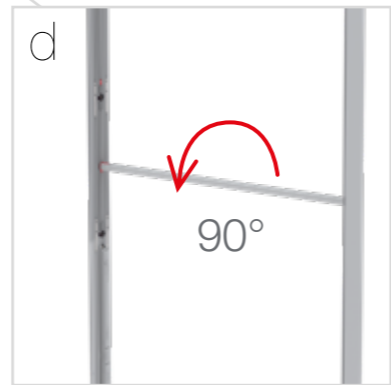
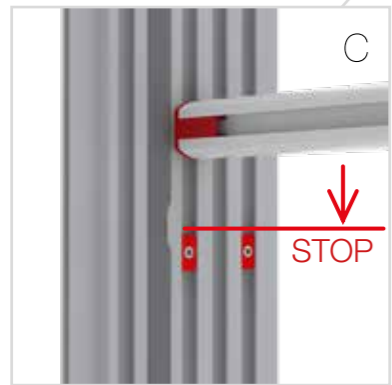
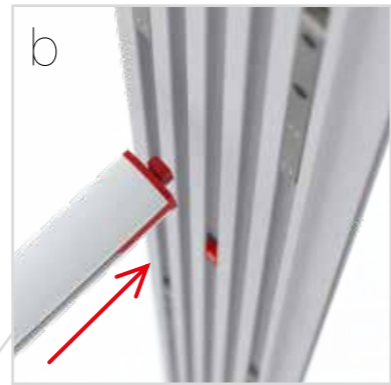
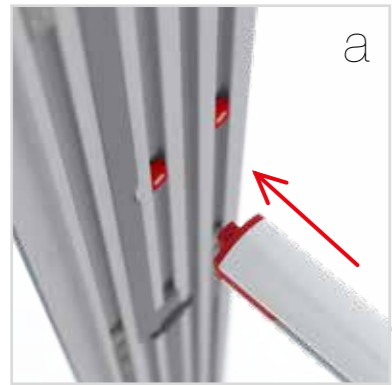

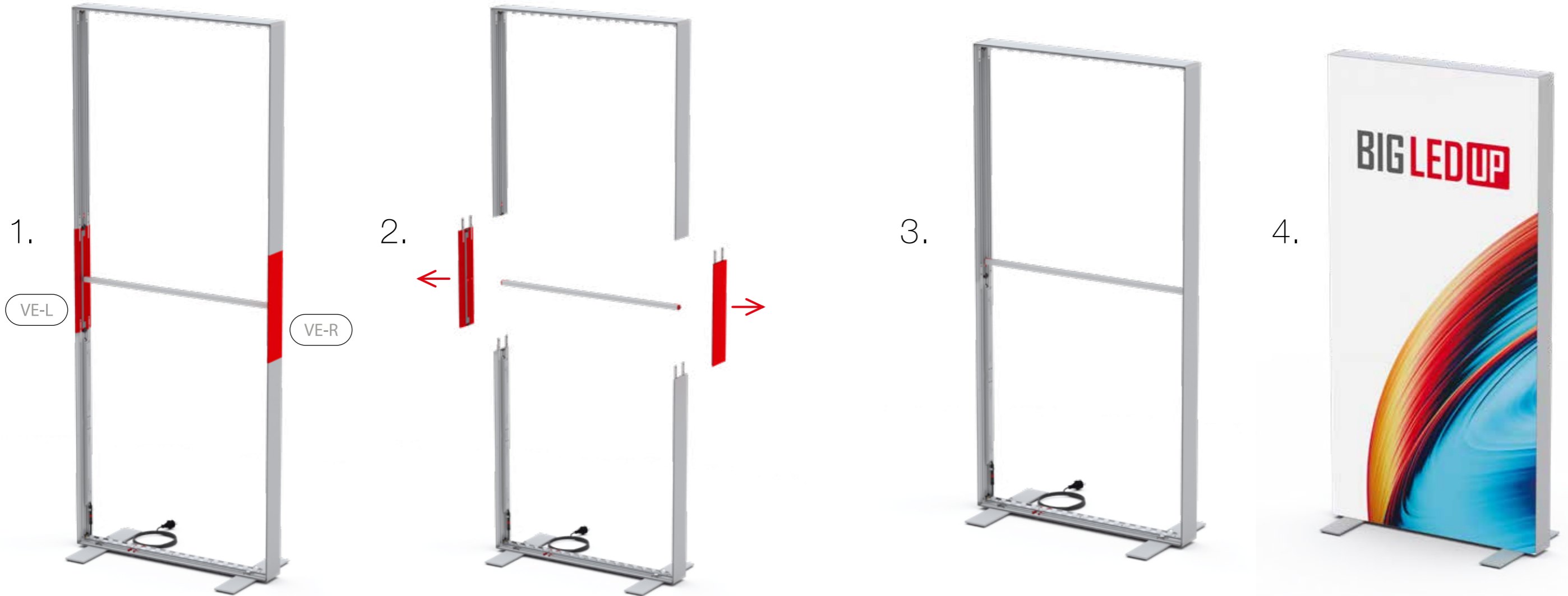

ZUBEHÖR
ACCESSORIES



BIG LED UP

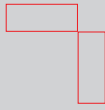
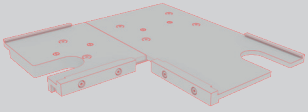

BLUP-conn-90

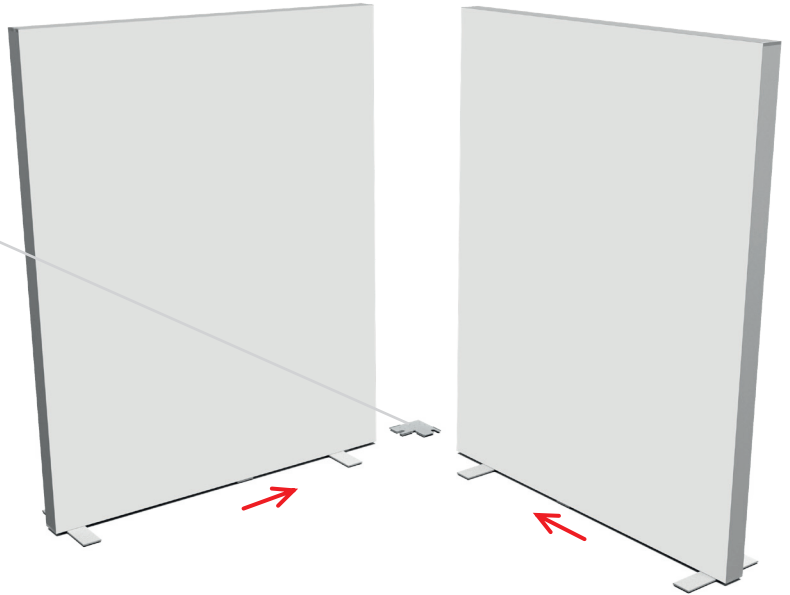
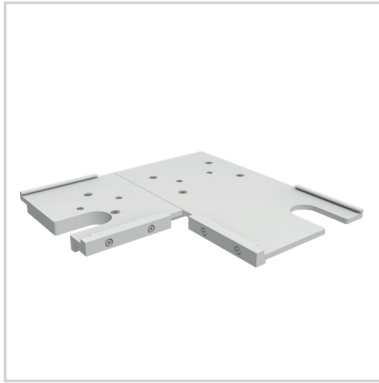

1.

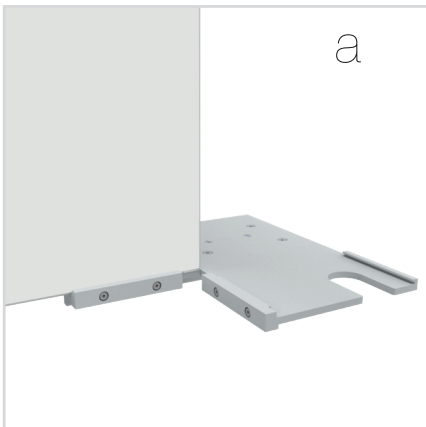

a

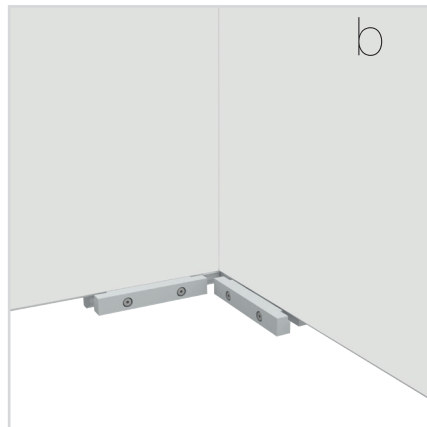

b

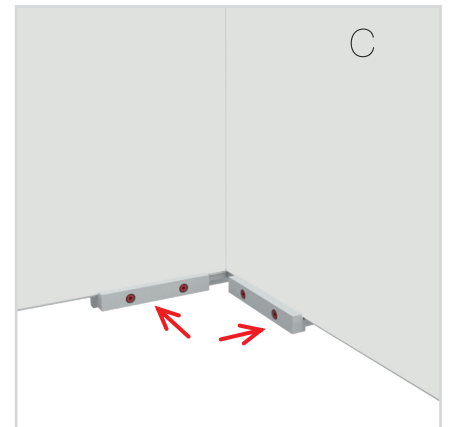

c

ECK KLEMME/ CORNER CLAMP

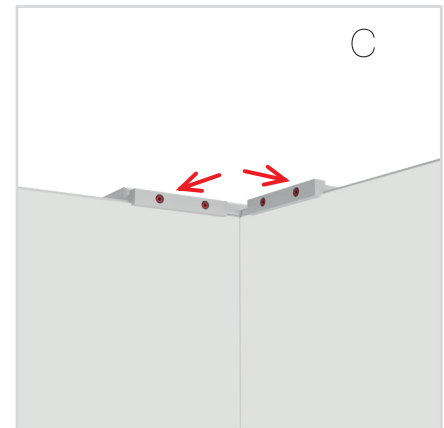
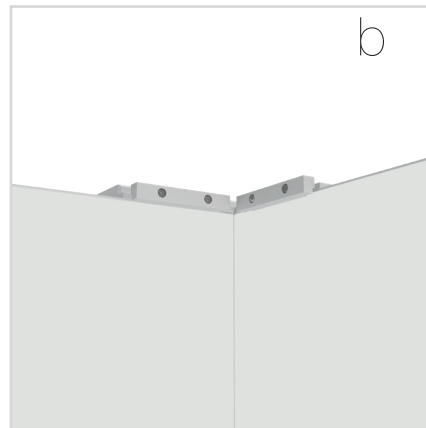
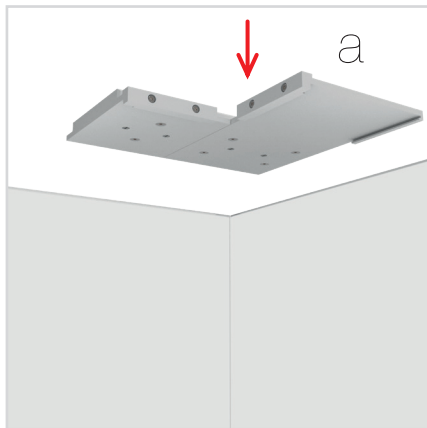
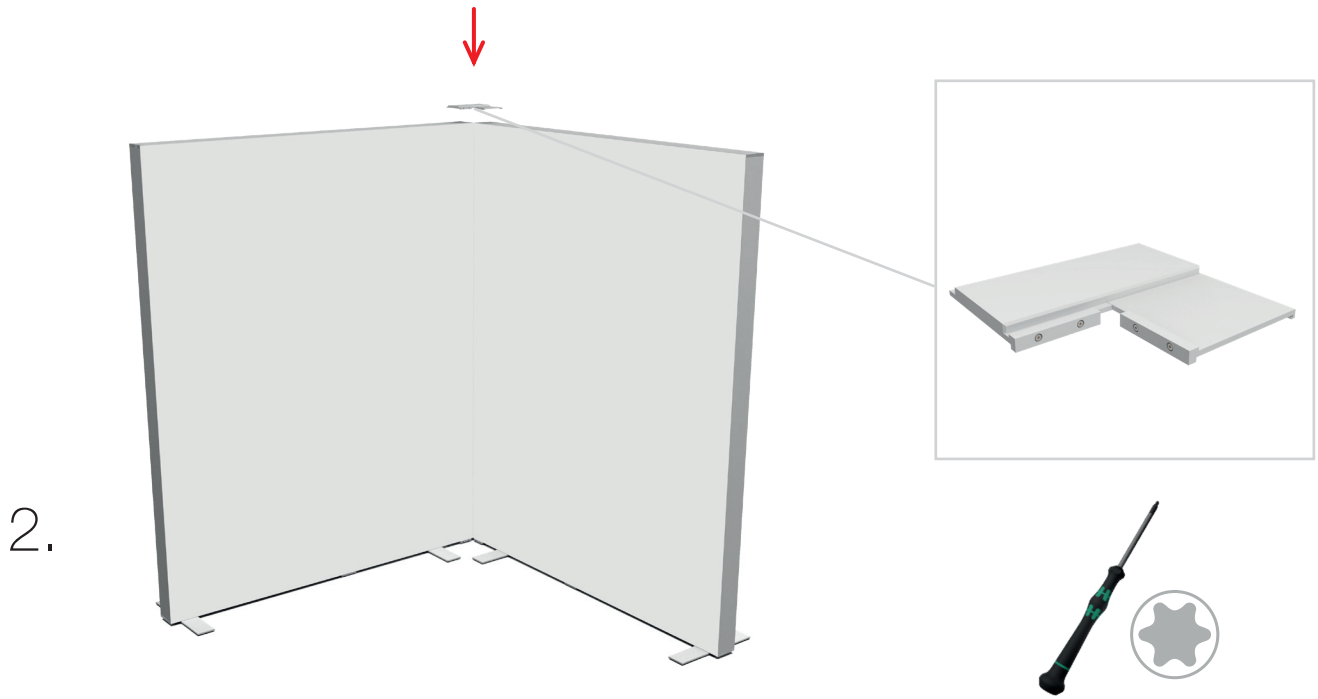



SET UP INSTRUCTION
ACCESSORIES

The text "BIG LED UP DOOR" is displayed in a bold, stylized font. The letters are filled with a vibrant, multi-colored gradient of blue, red, and yellow, creating a sense of motion and energy. The text is set against a solid black background and is enclosed within a thin red rectangular border.

**BIG LED UP
DOOR**

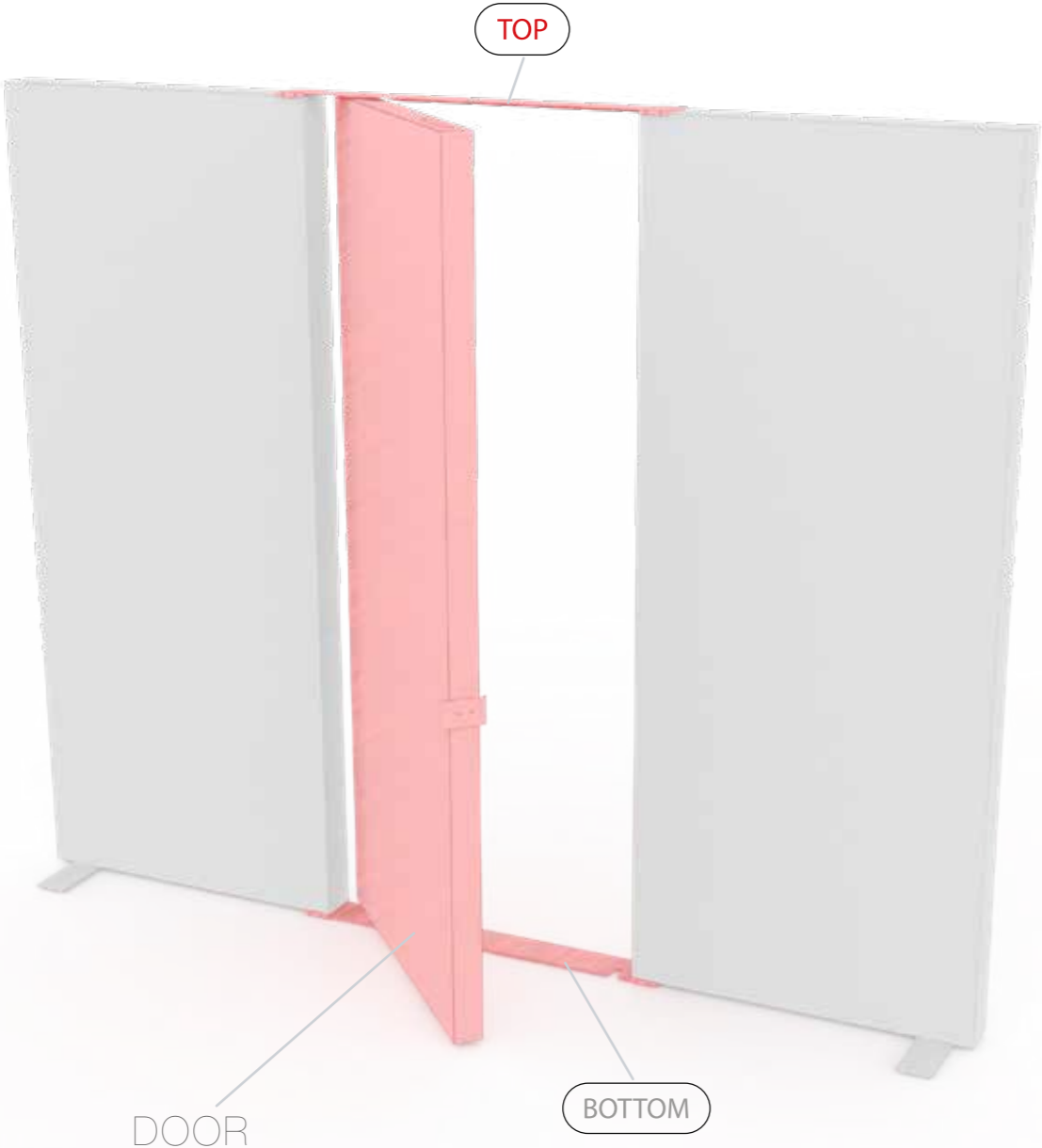

Gerade Version/straight version 4
Aufbauanleitung/set up instruction

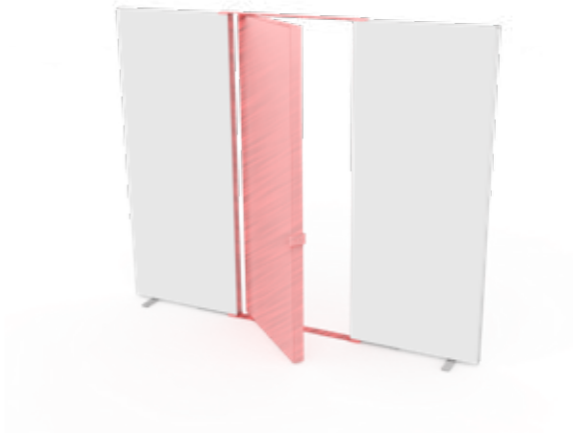

Eck- & Kojenversion/corner & storage version.....30
Aufbauanleitung/set up instruction



BIG LED UP DOOR

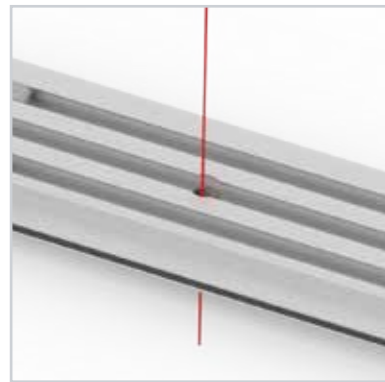

AXIS

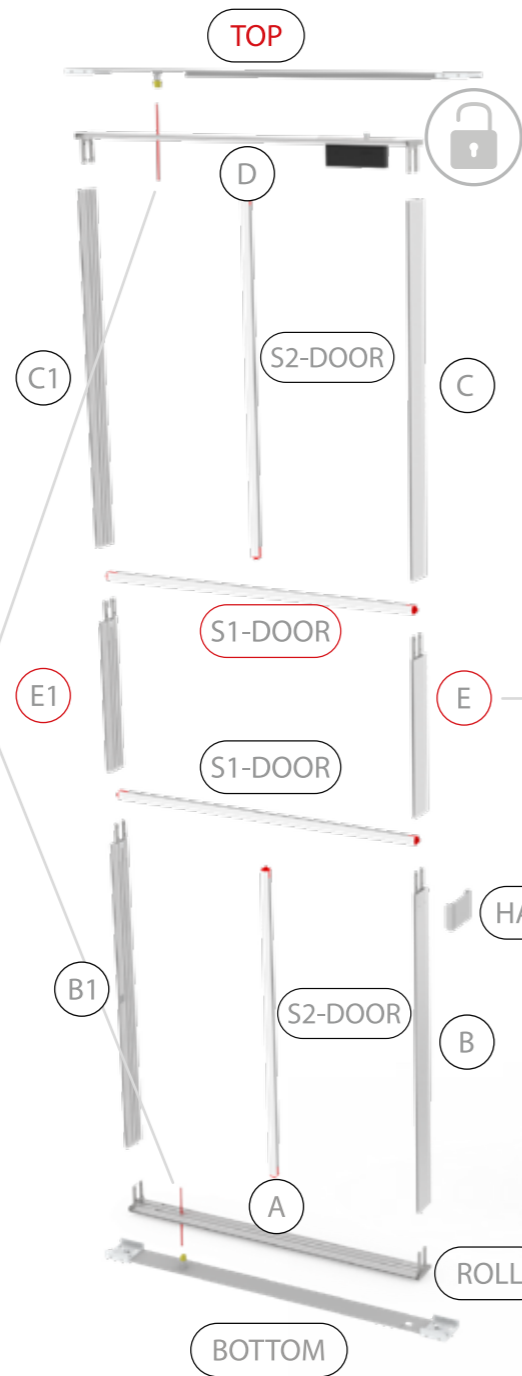

RAHMENGRÖSSE/FRAME
SIZE: 98 x 199,2 / 239,2 / 297,2cm

E1 S1-DOOR E
NUR FÜR DIE HÖHE
240/298 ERFORDERLICH
ONLY NEEDED FOR THE
HEIGHT 240/298



1.

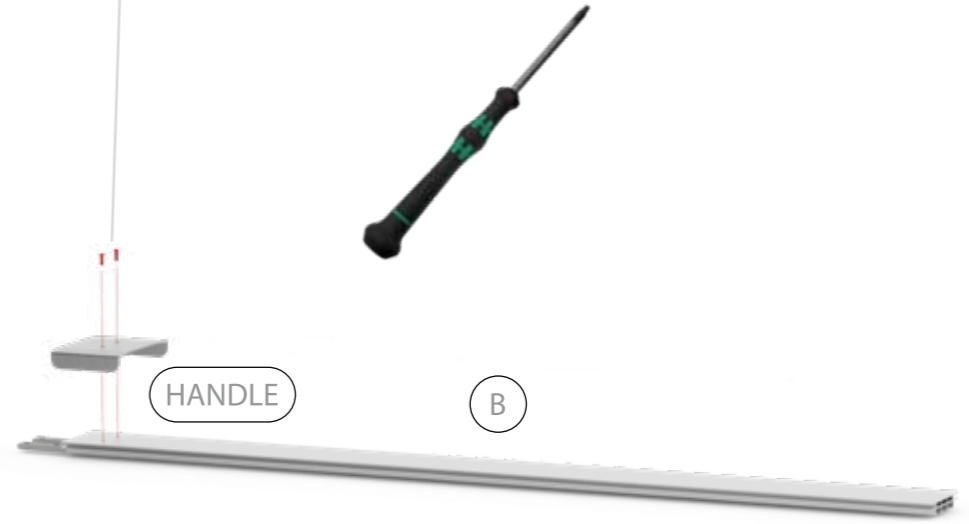

TÜR/DOOR

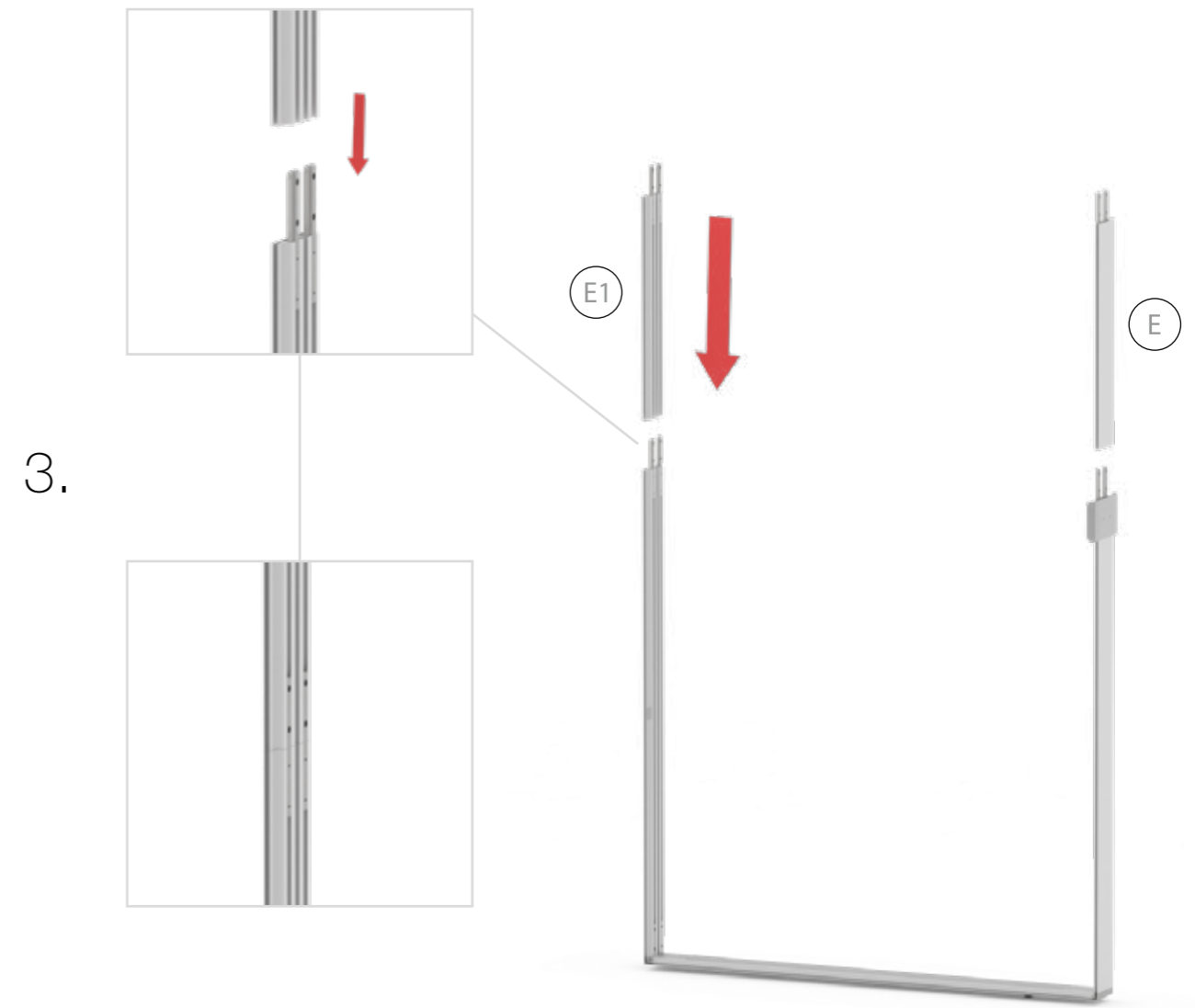
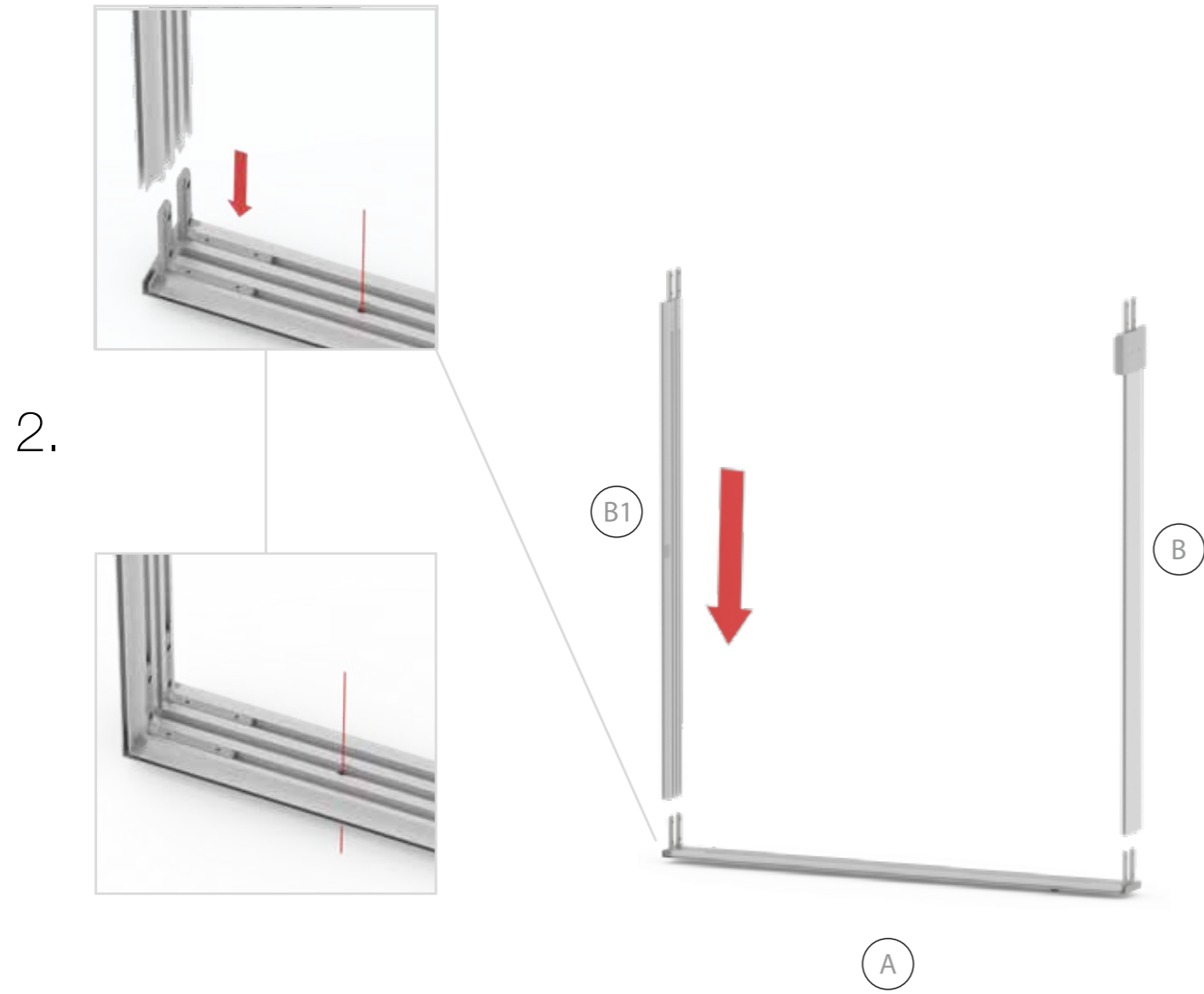

TÜR/DOOR

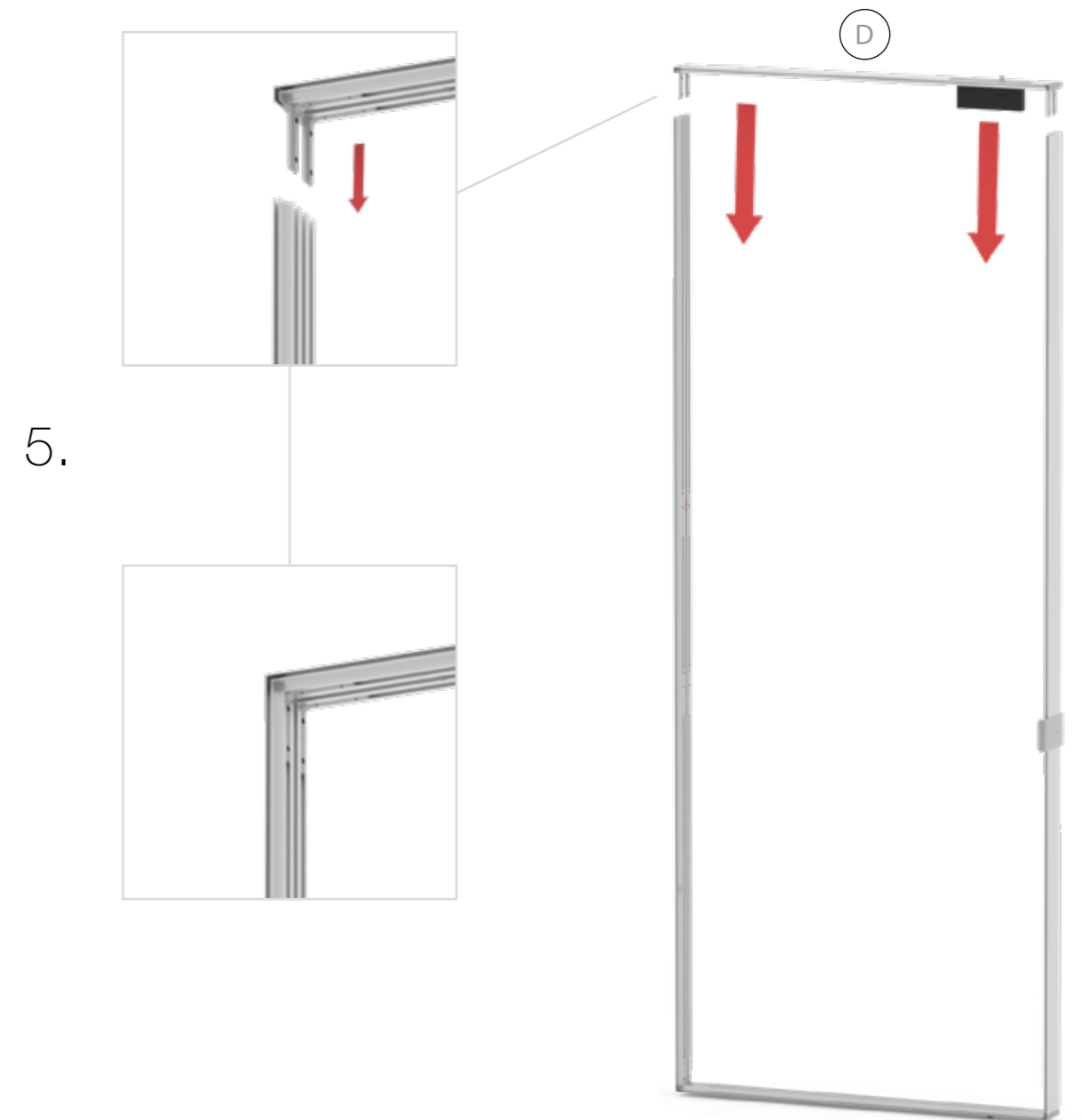
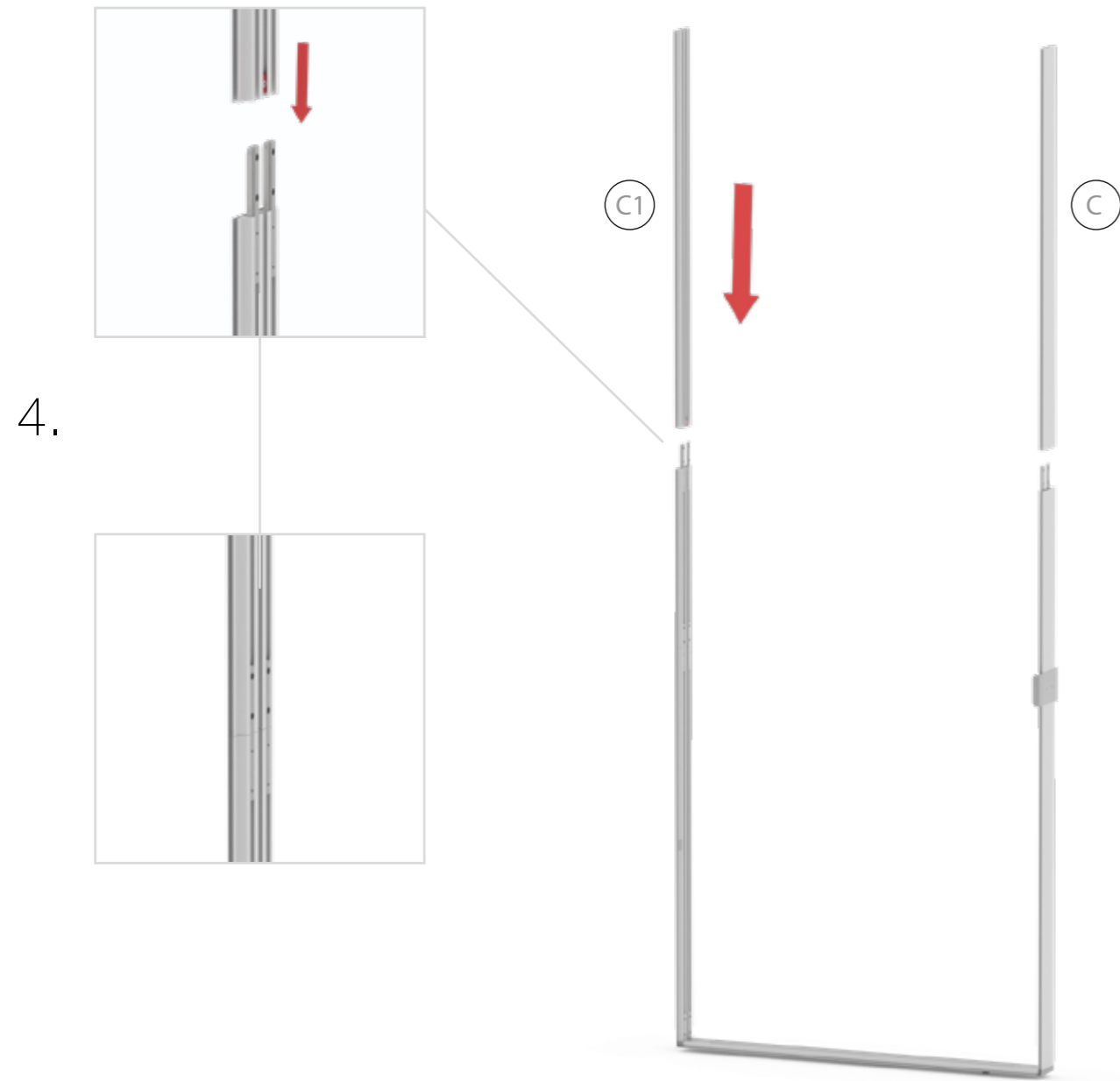

TÜR/DOOR

6.

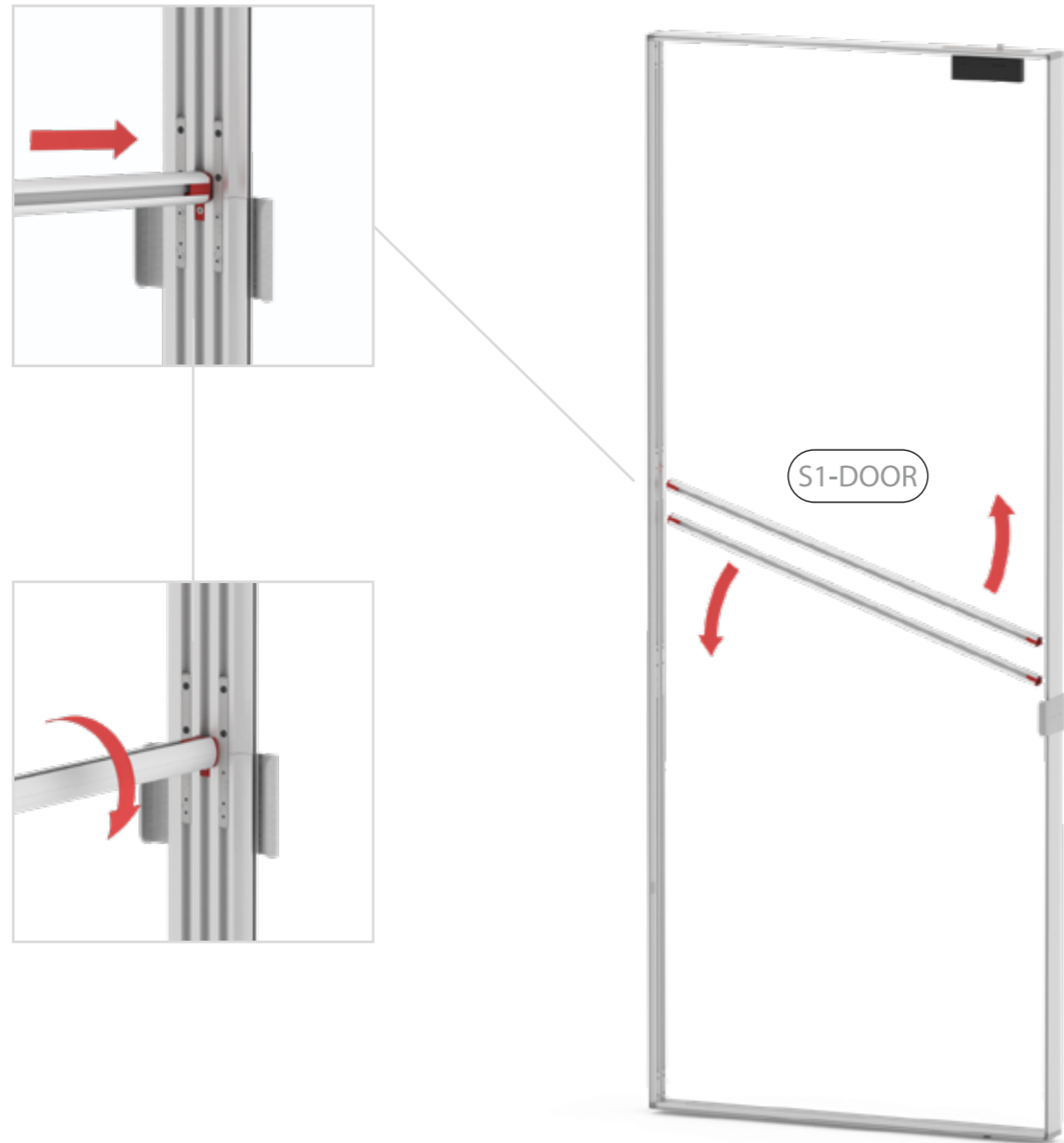

7.

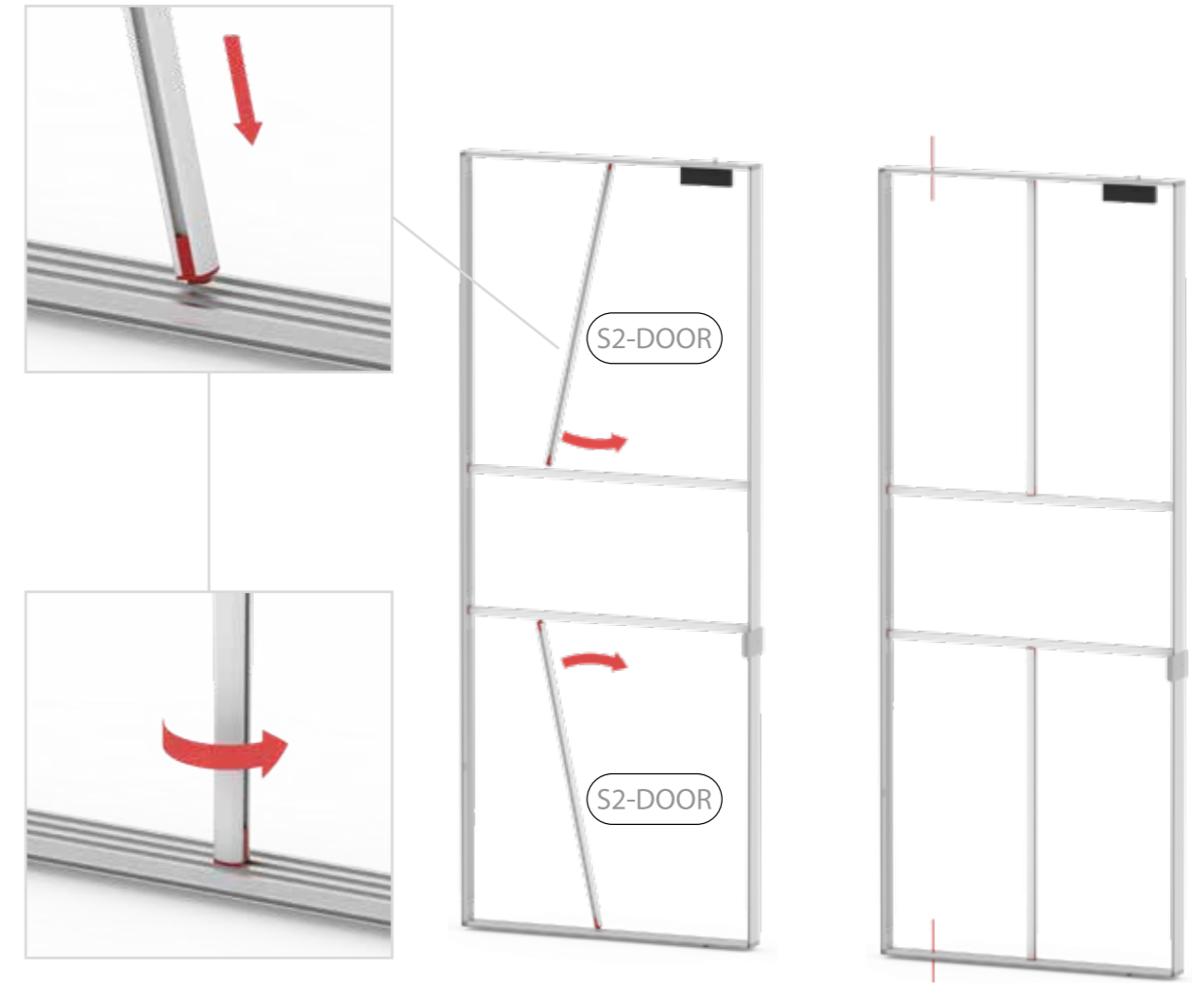

GERADE VERSION/STRAIGHT VERSION

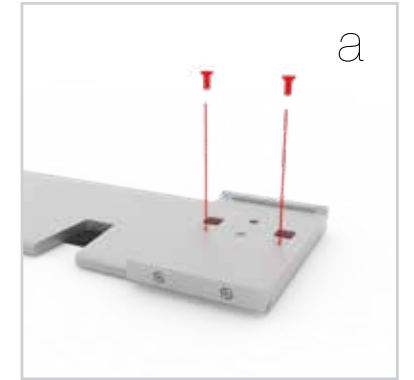
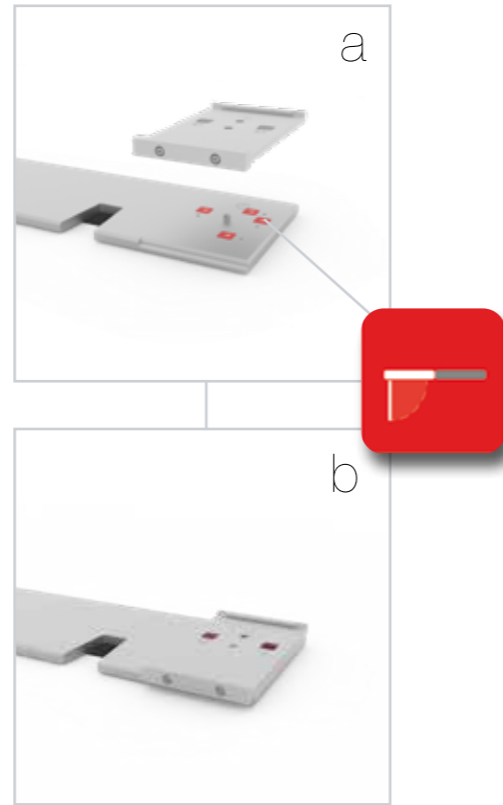
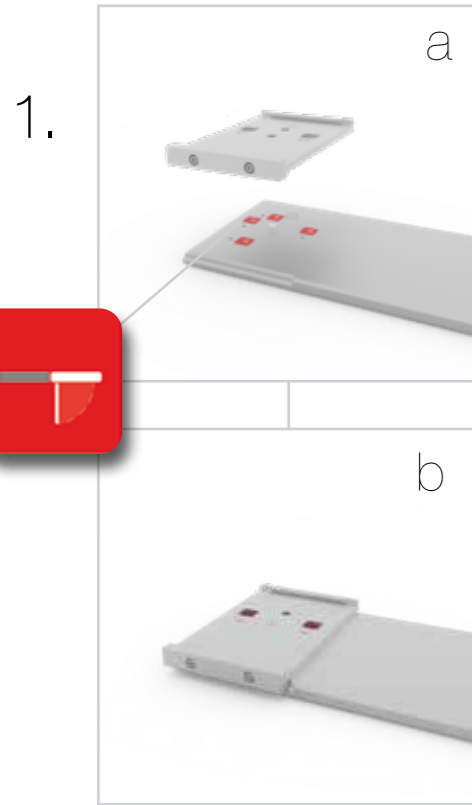

GERADE VERSION/STRAIGHT VERSION

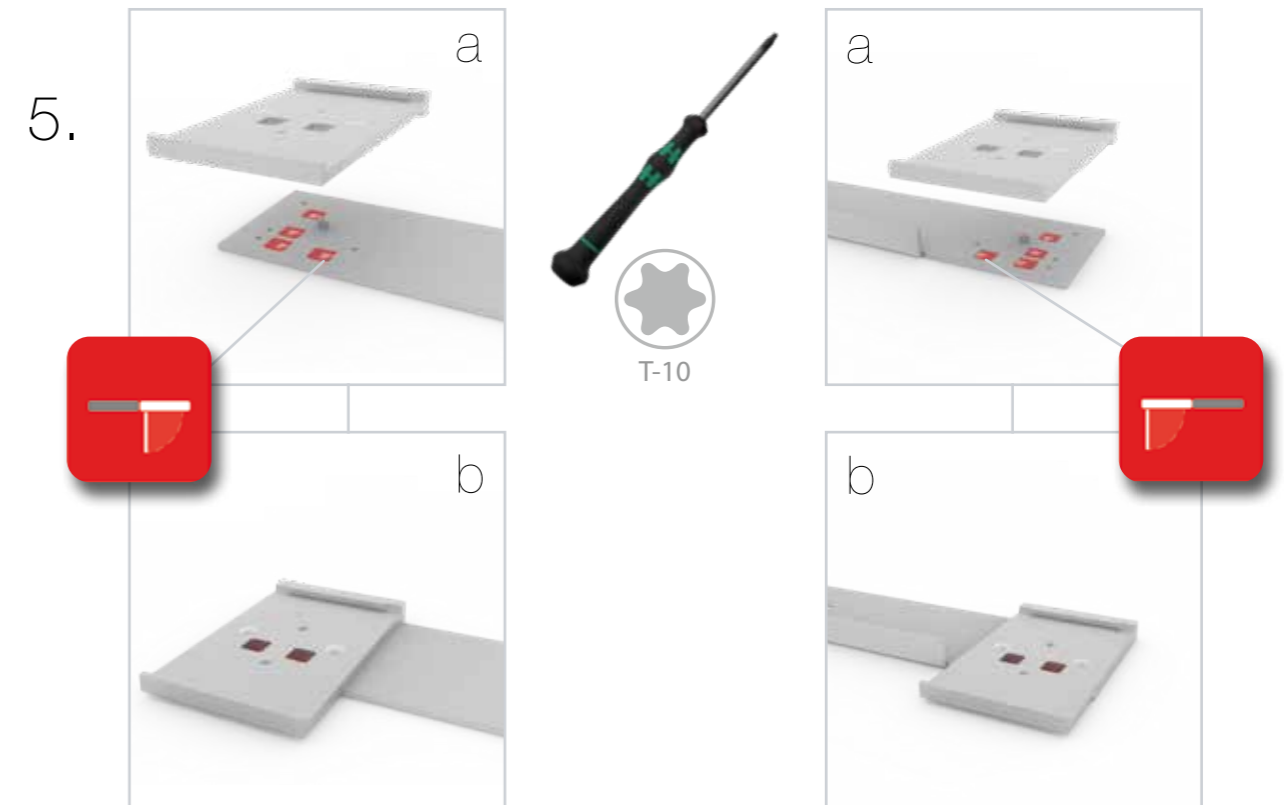
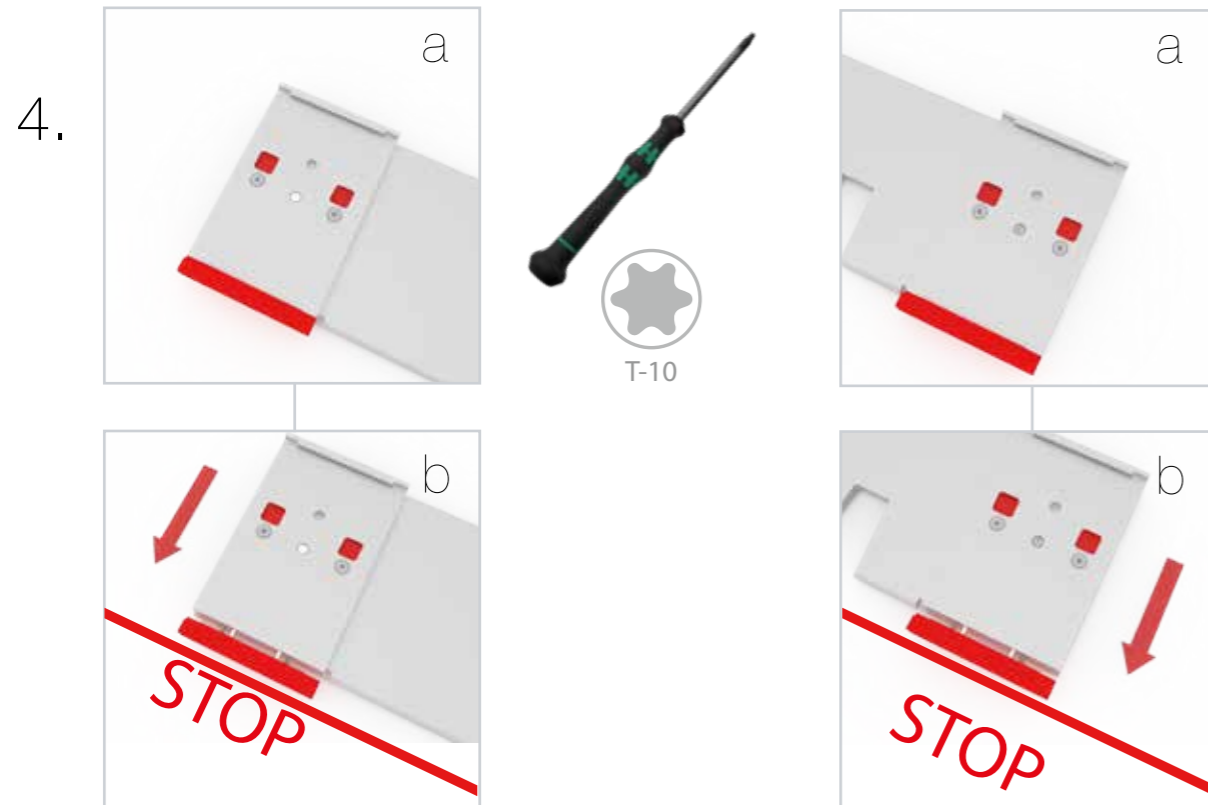

GERADE VERSION/STRAIGHT VERSION

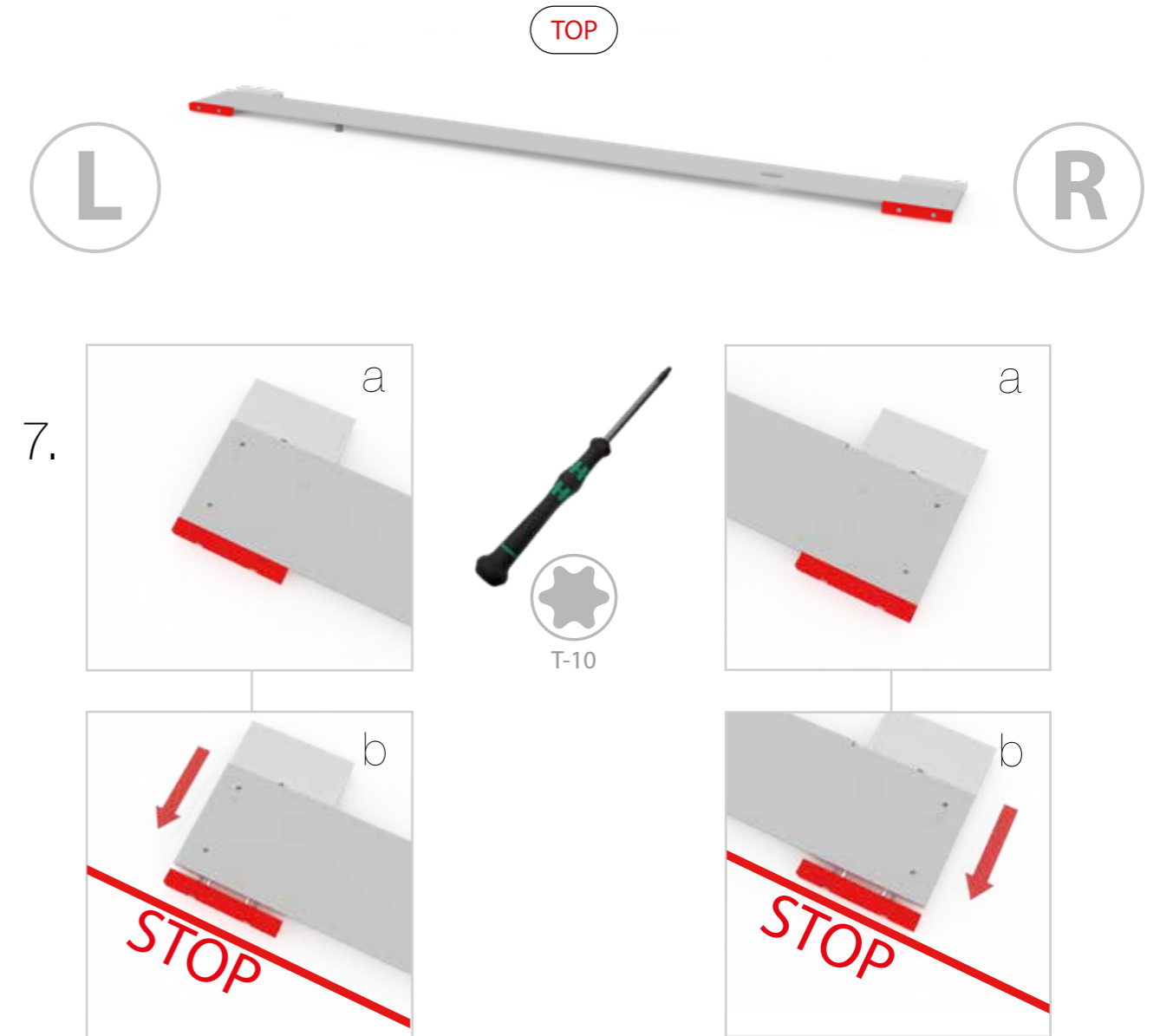
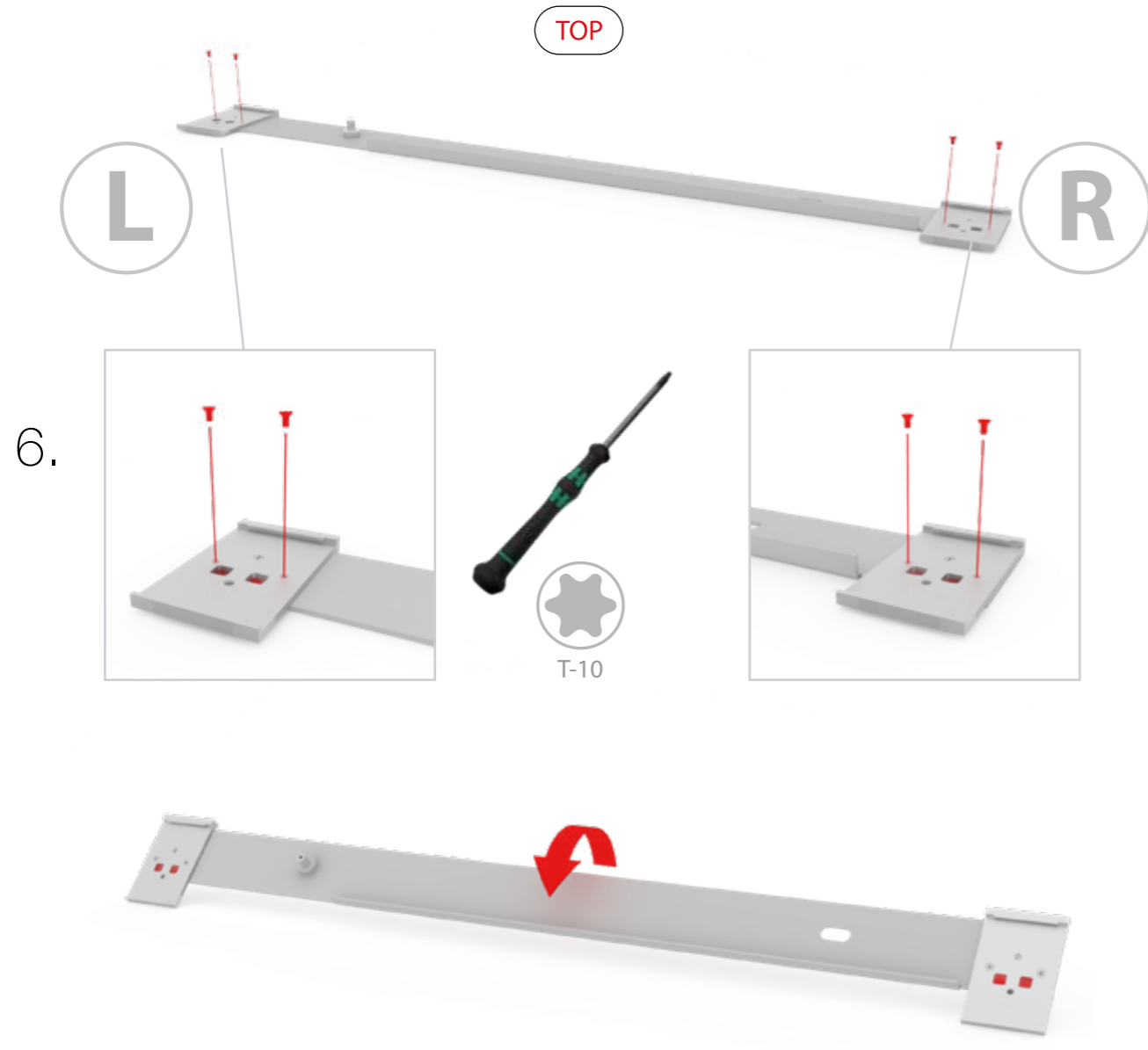

GERADE VERSION/STRAIGHT VERSION

8.

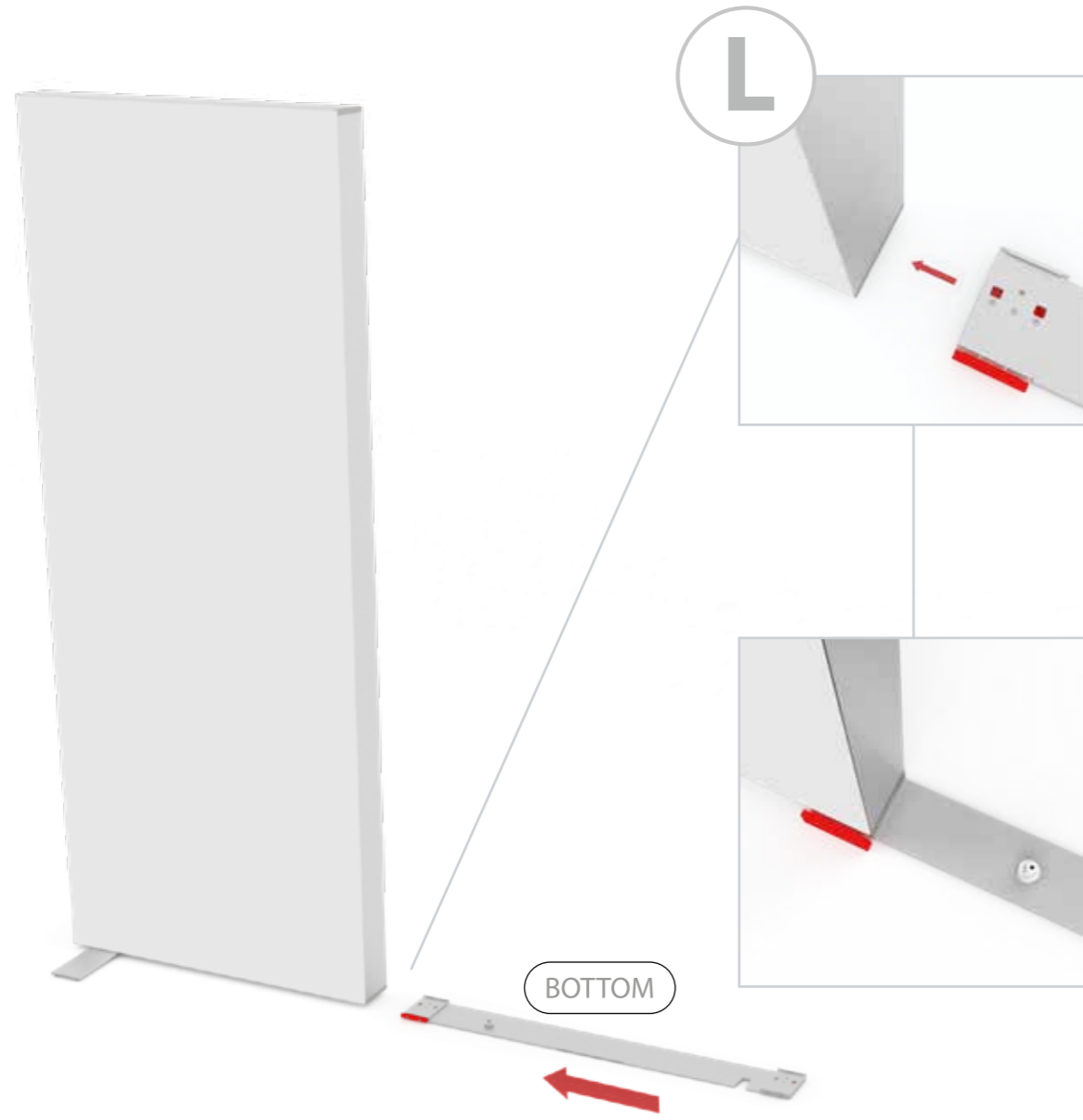

9.

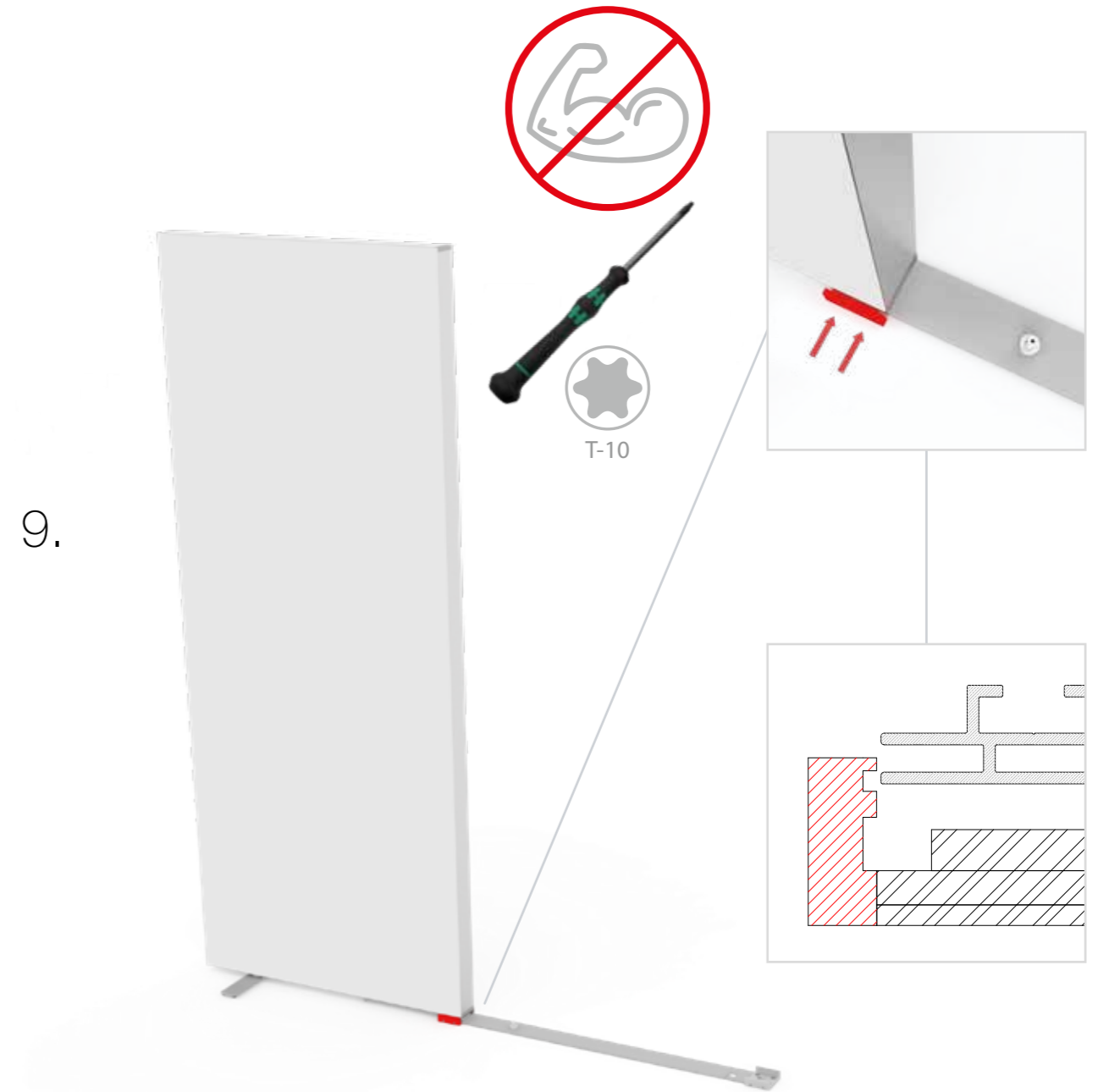

GERADE VERSION/STRAIGHT VERSION

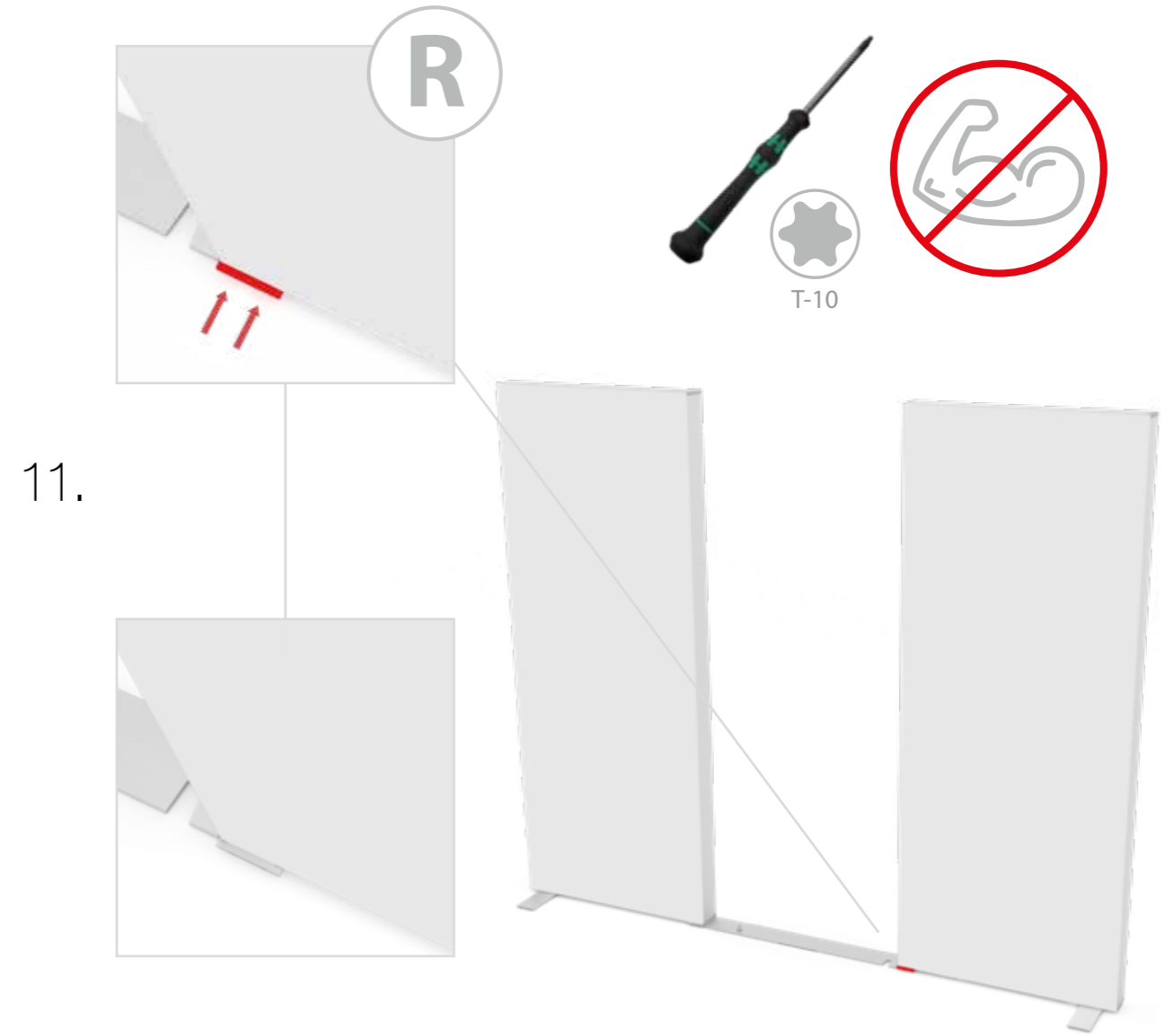
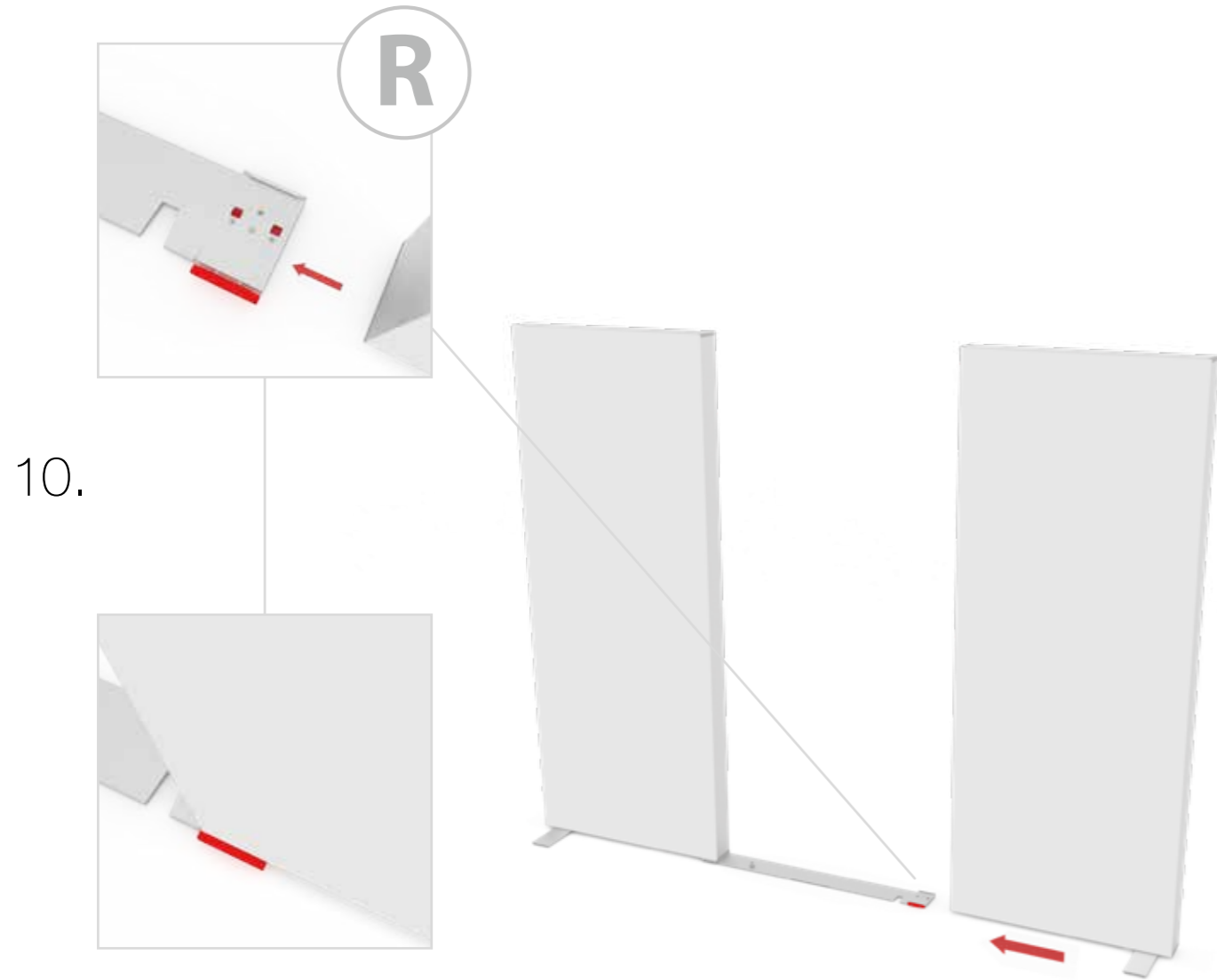

GERADE VERSION/STRAIGHT VERSION

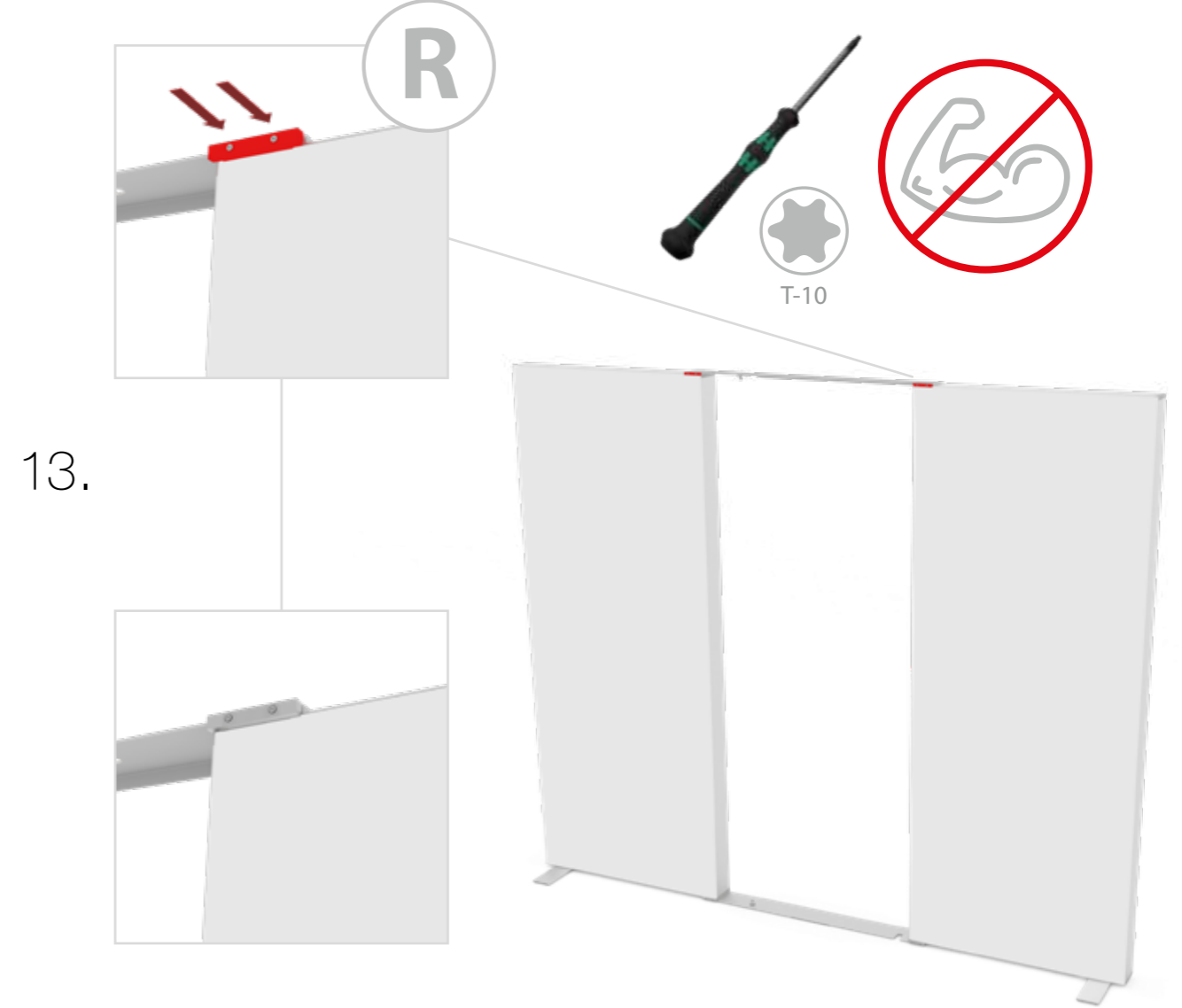
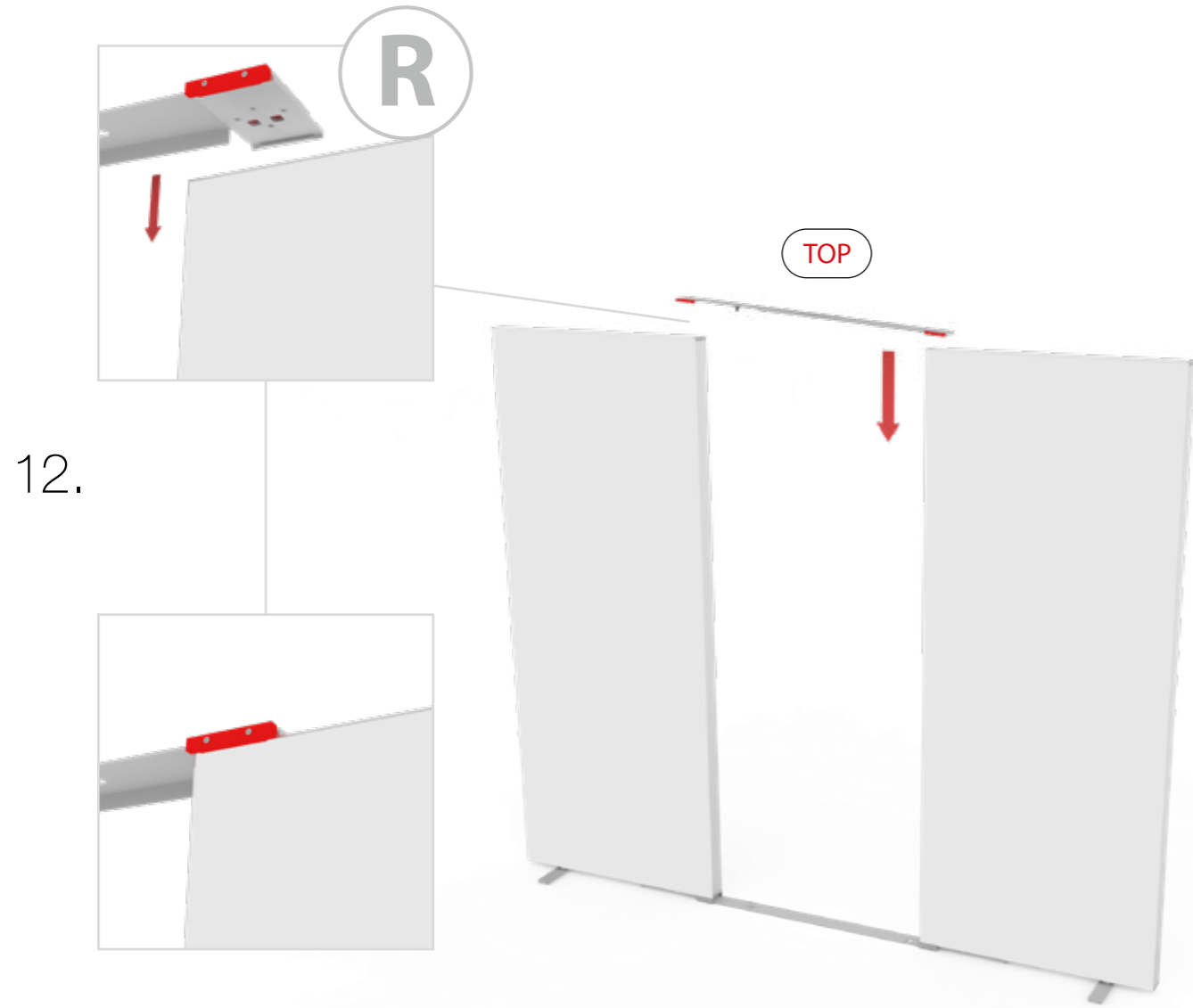

GERADE VERSION/STRAIGHT VERSION

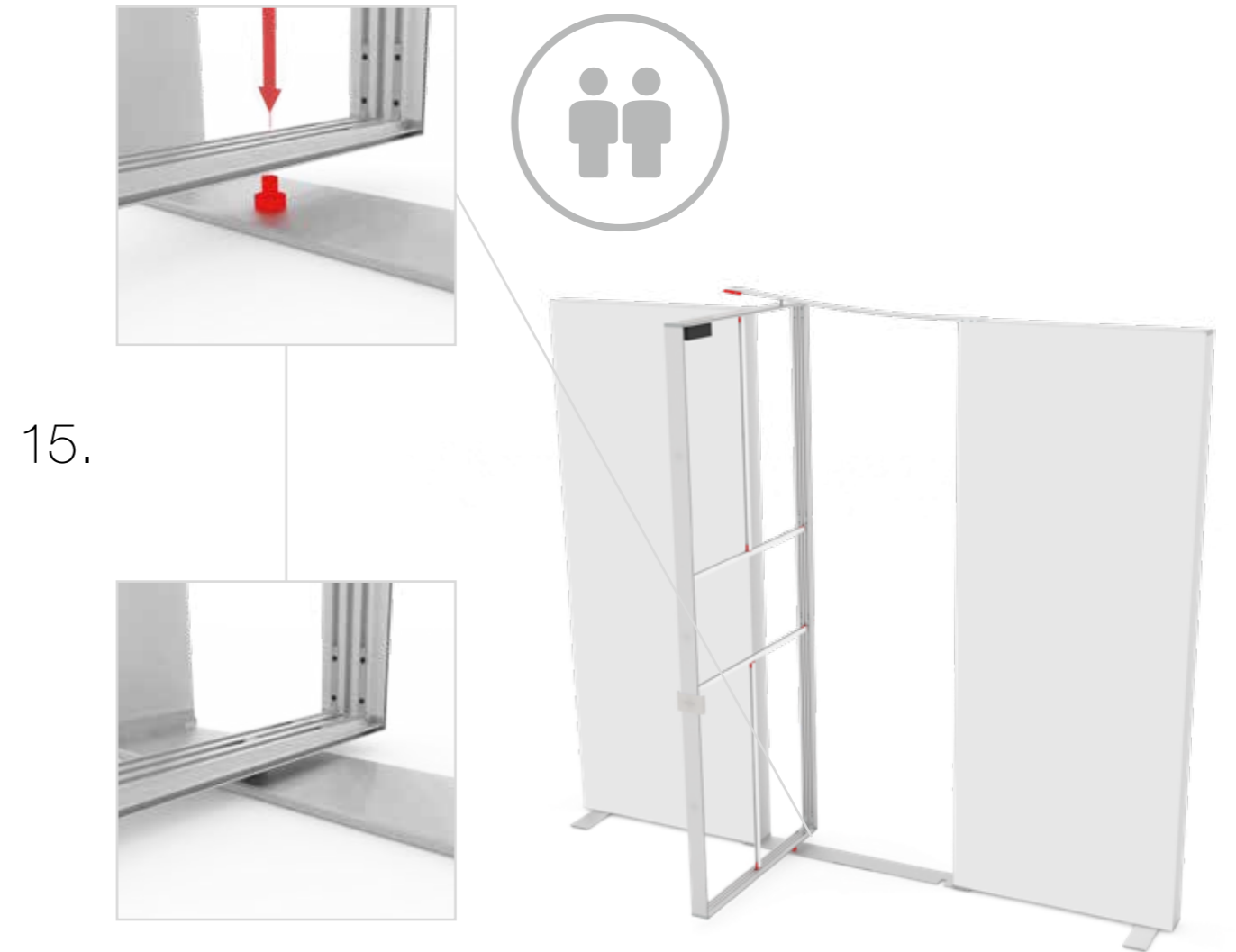
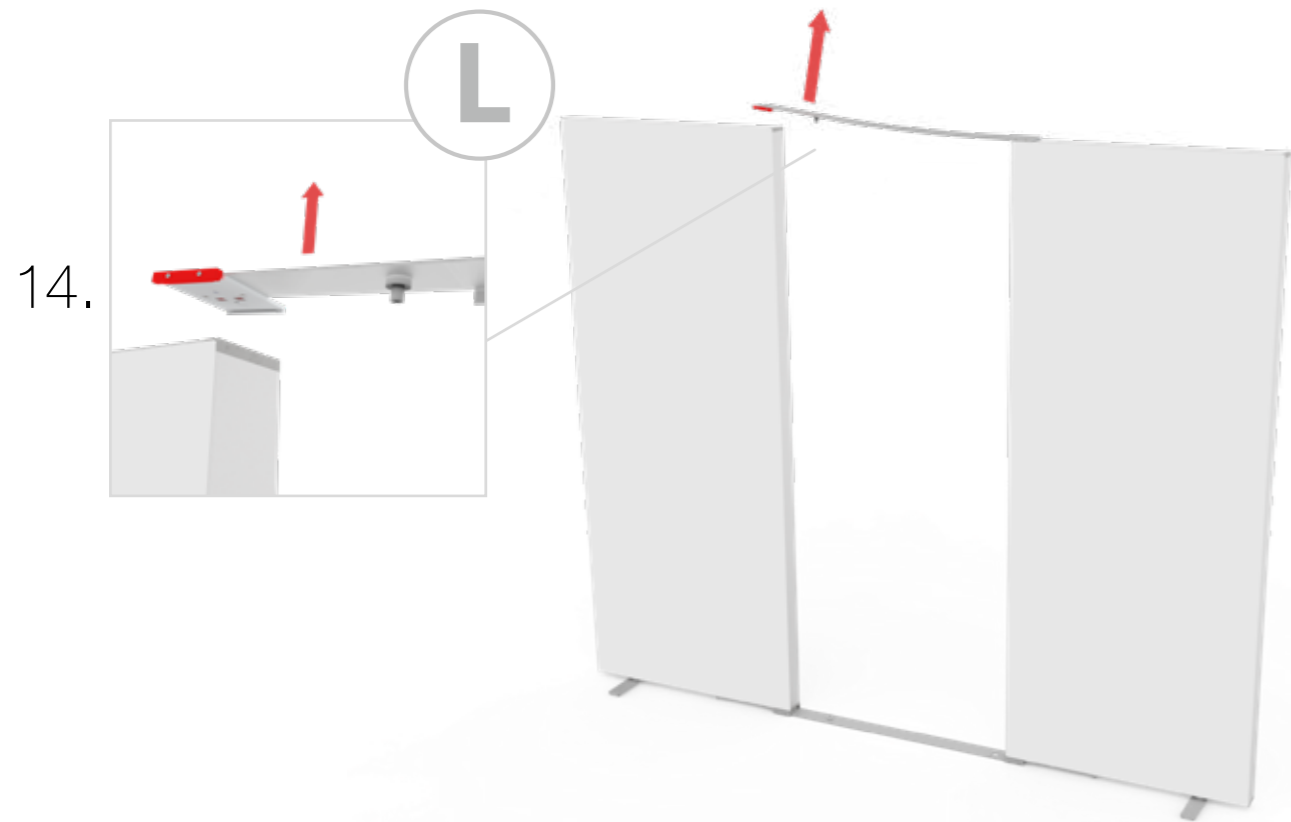

GERADE VERSION/STRAIGHT VERSION

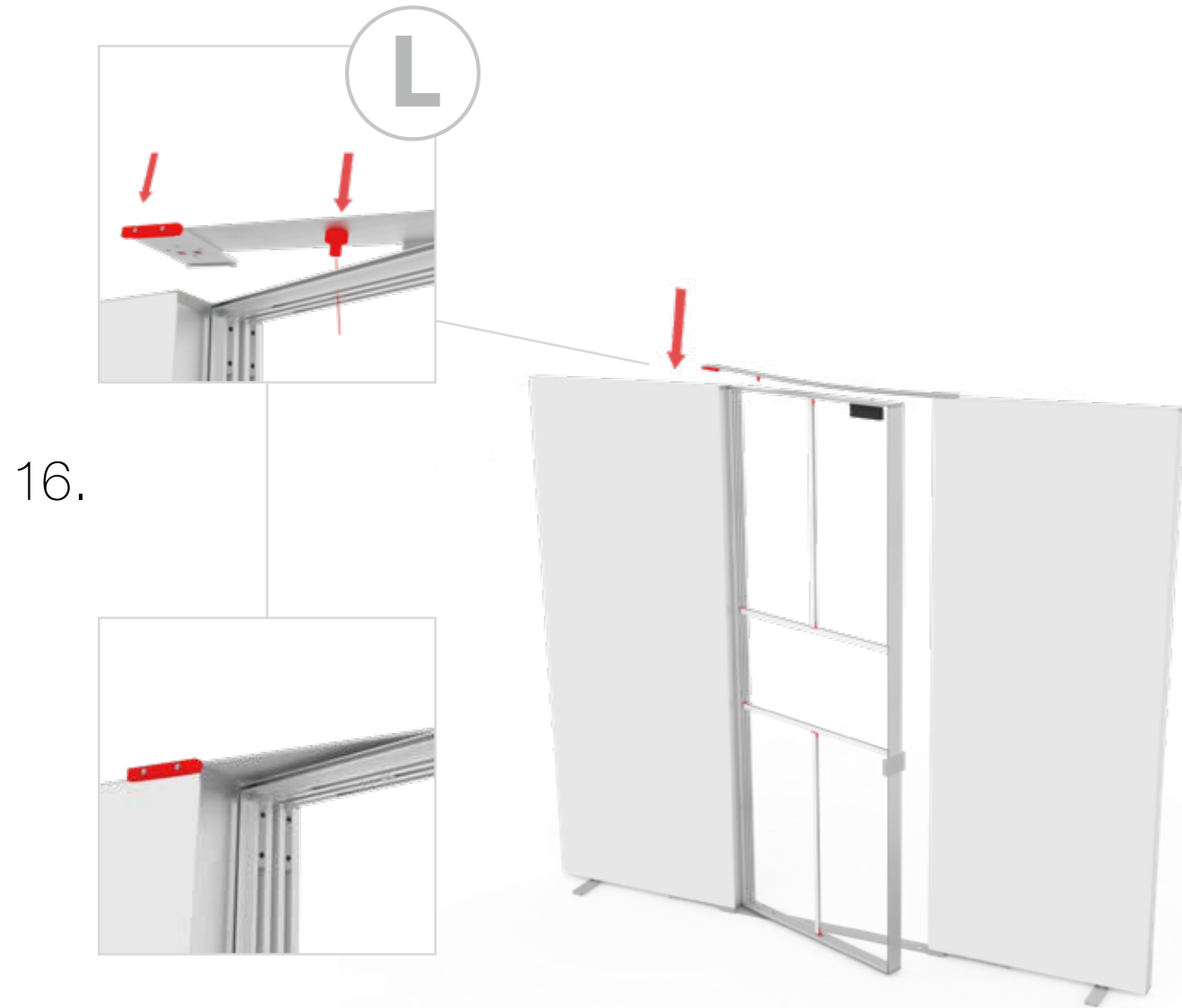

GERADE VERSION/STRAIGHT VERSION

GERADE VERSION/STRAIGHT VERSION

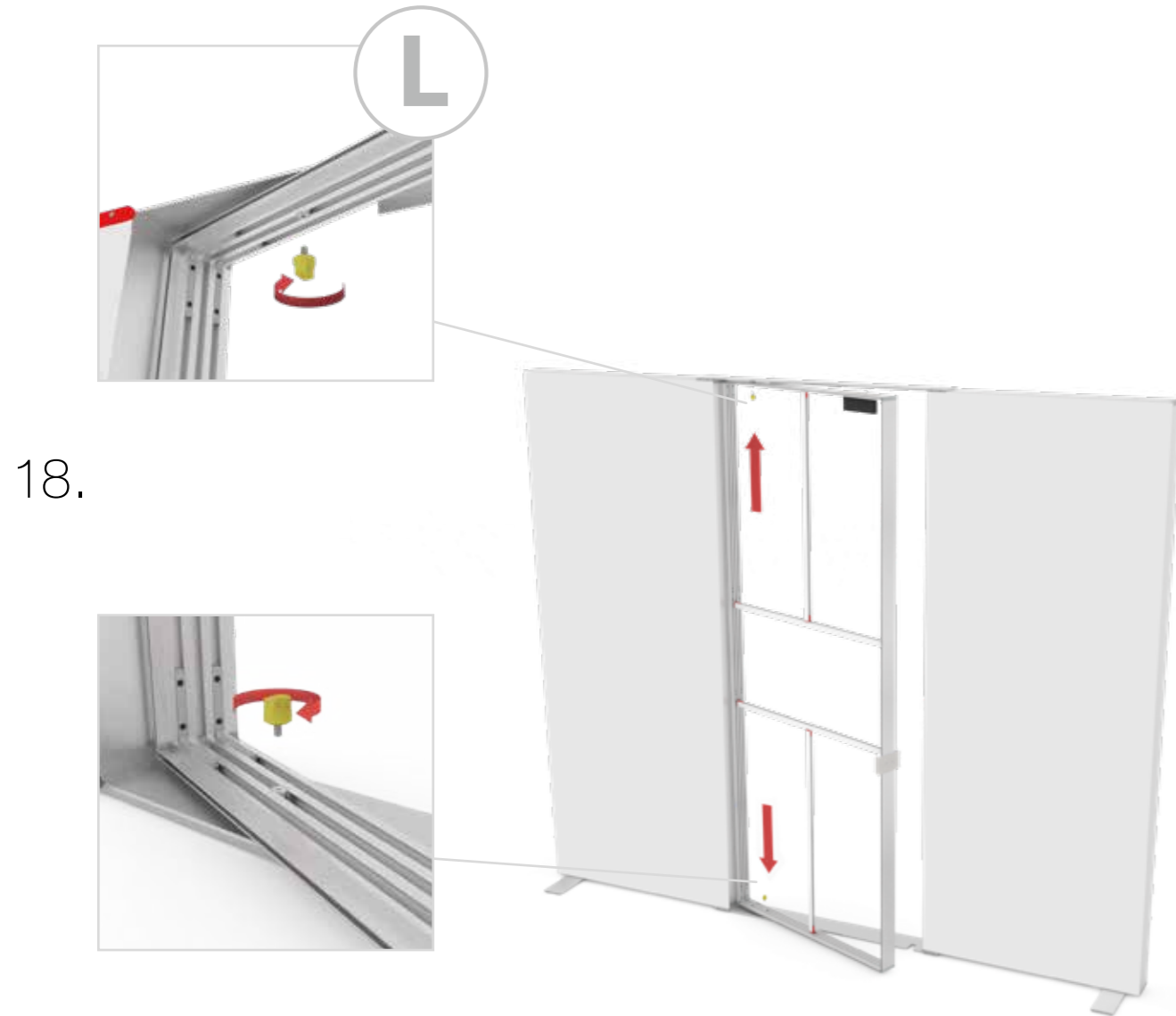

2 SEK. DRÜCKEN
PRESS FOR 2 SEC.

ECK- & KOJENVERSION/CORNER & STORAGE VERSION

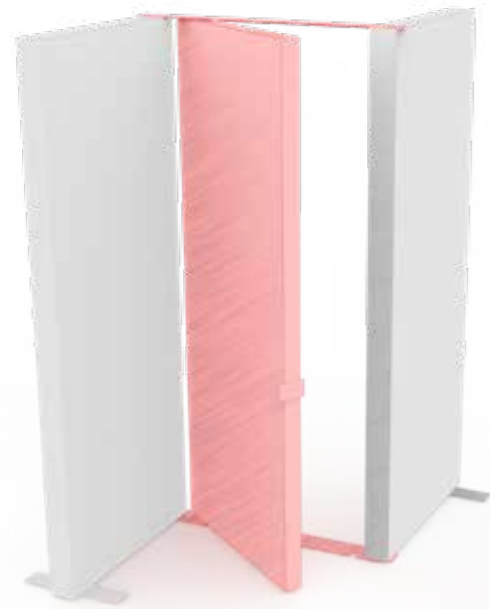

corner-L



corner-R



storage room

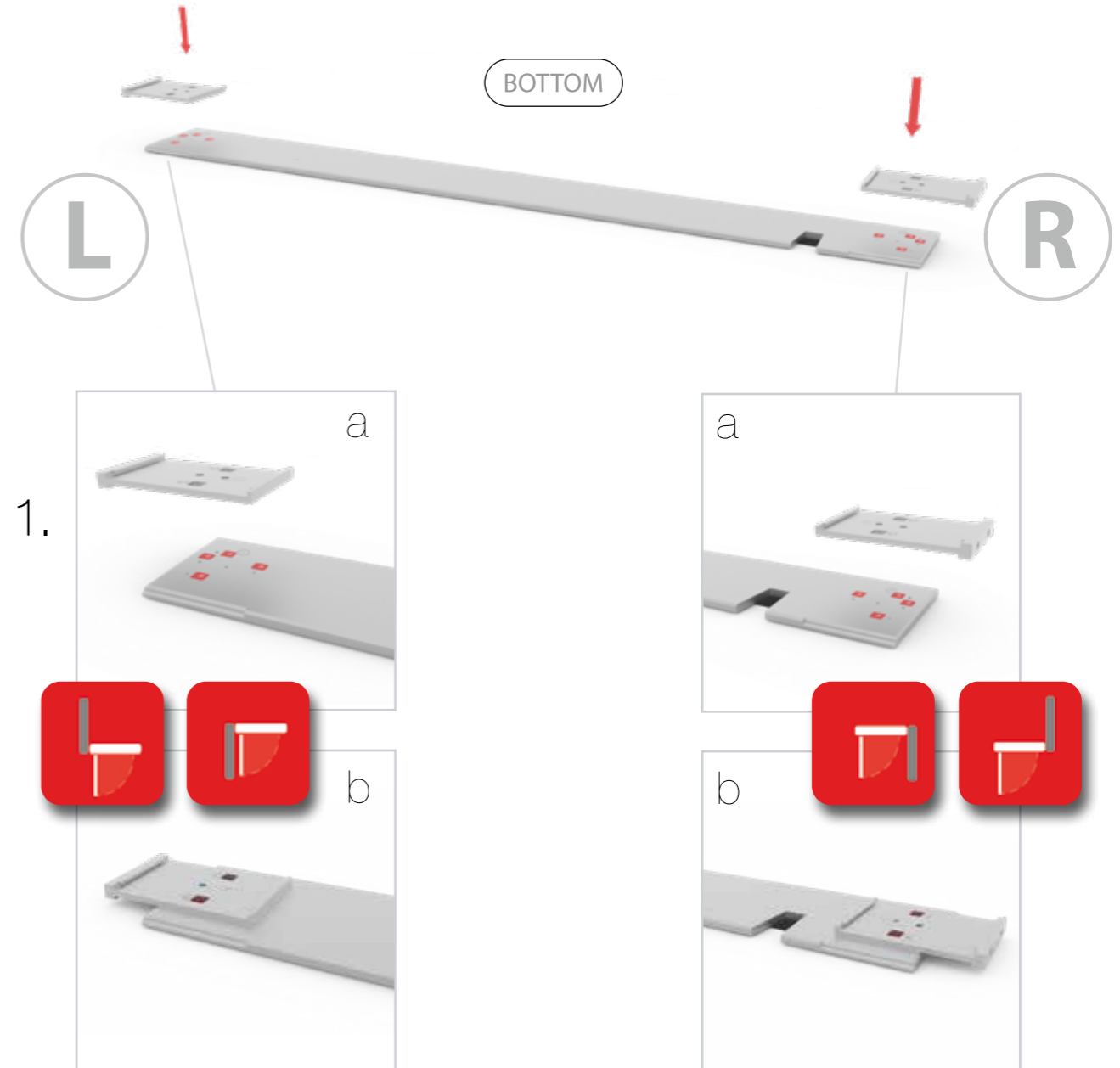

ECK- & KOJENVERSION/CORNER & STORAGE VERSION

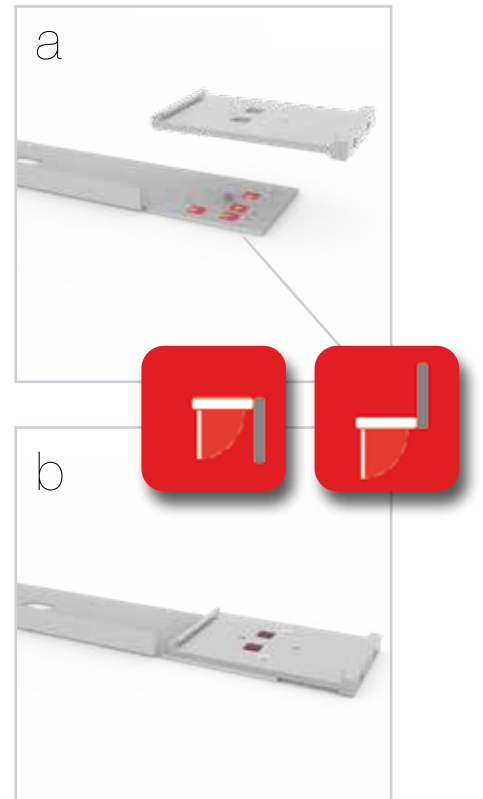
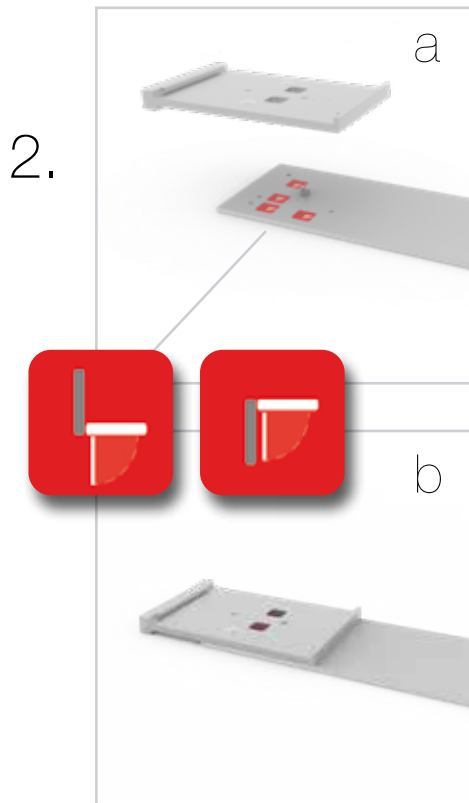

AUFBAUANLEITUNG SETUP INSTRUCTION



COUNTER

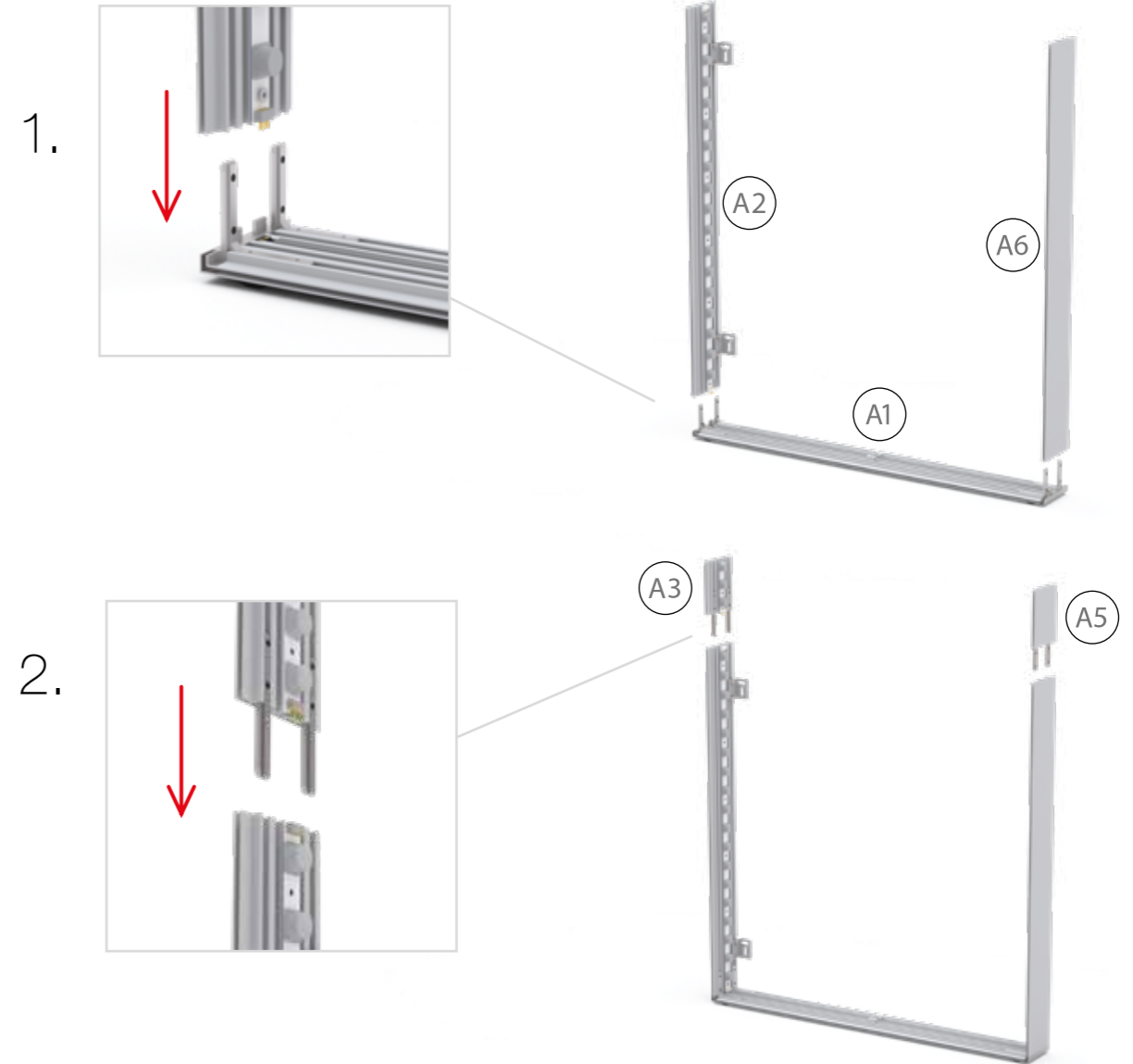

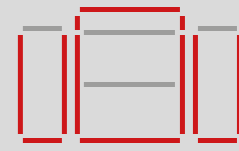
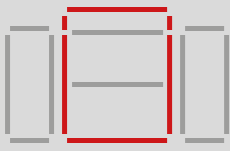

3.



5.

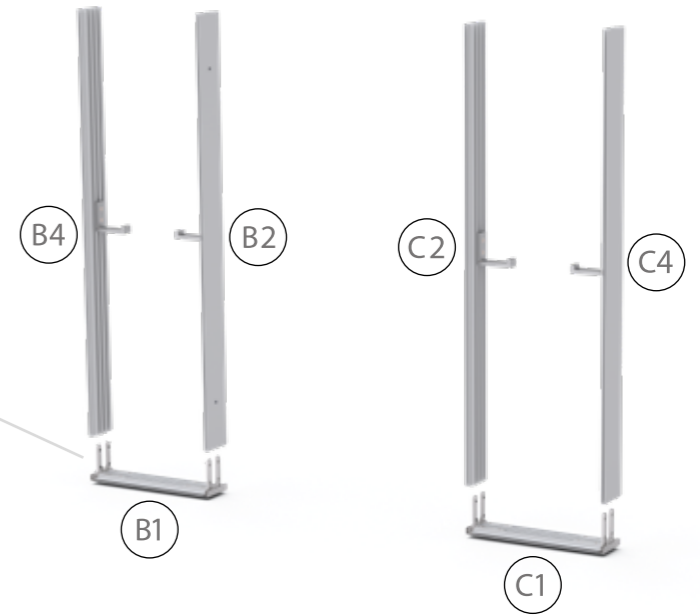
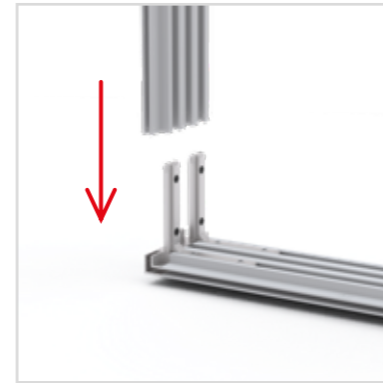

4.



6.

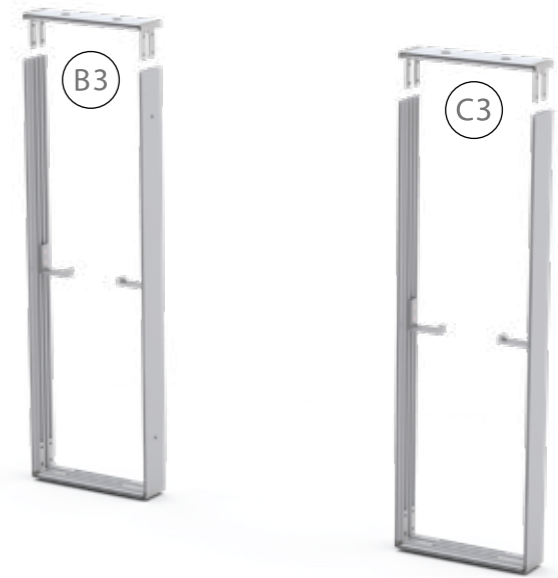

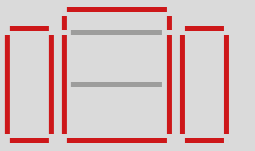
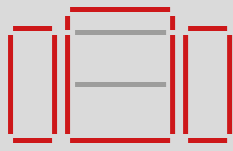

7.

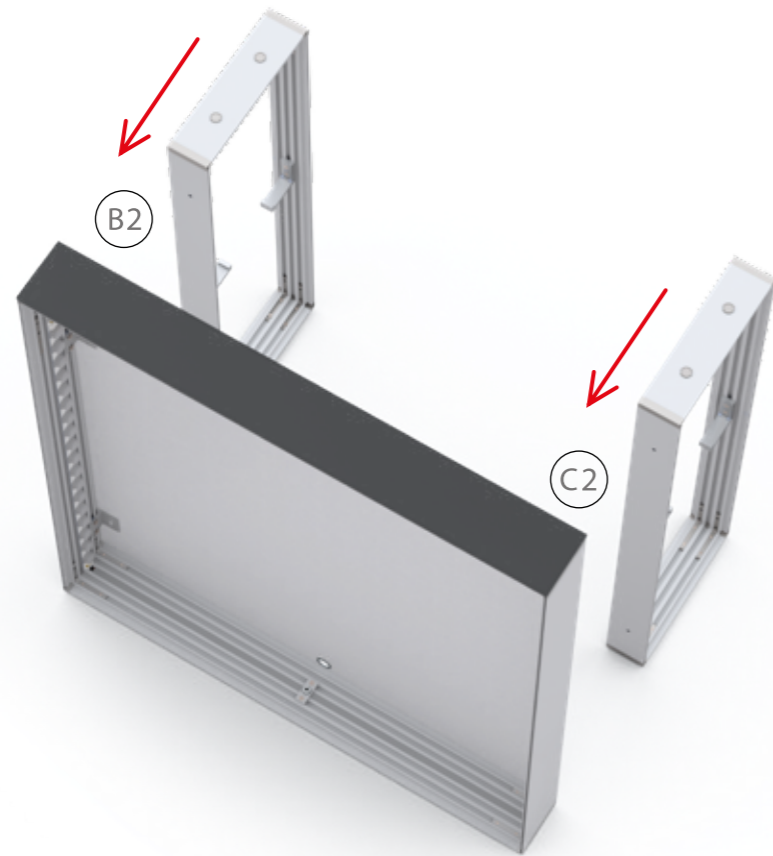

8.

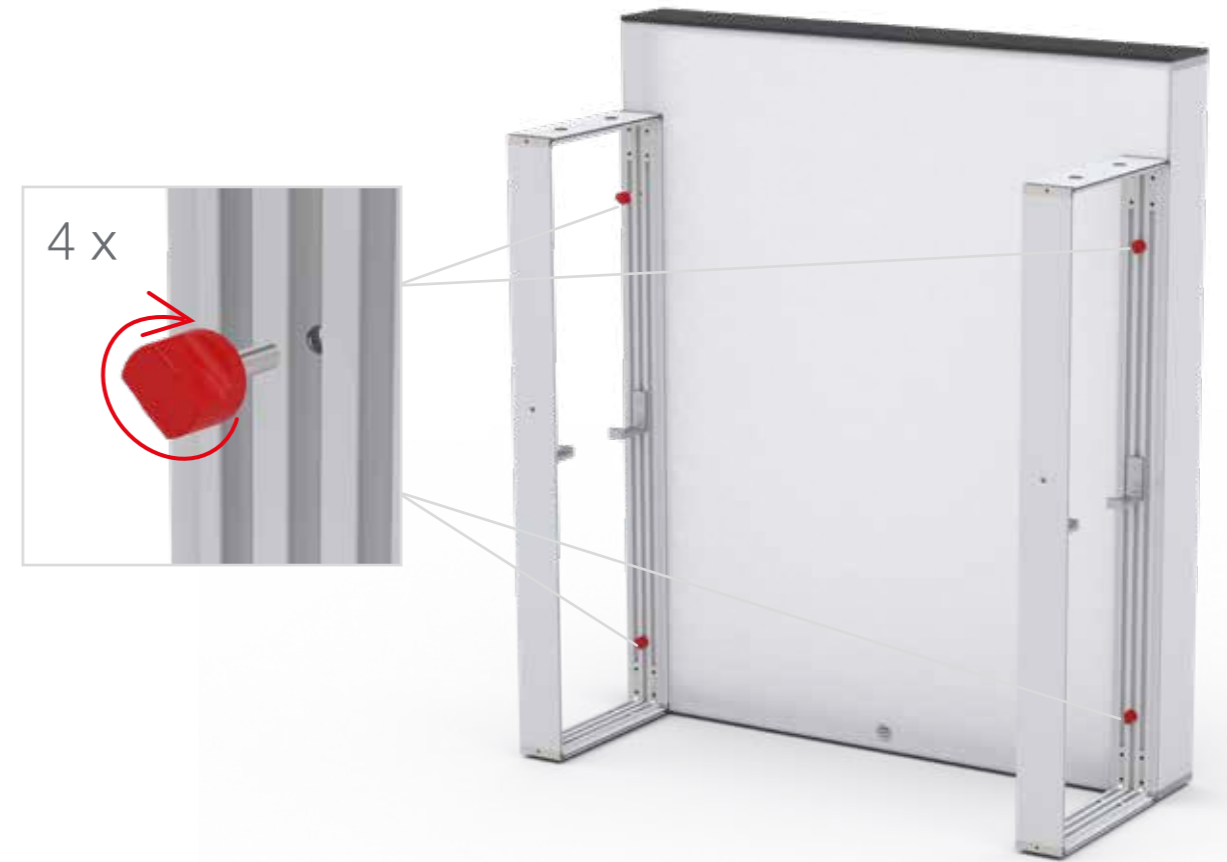

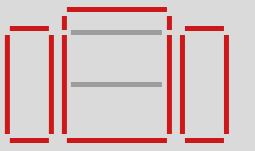
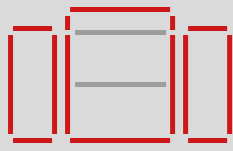

9.

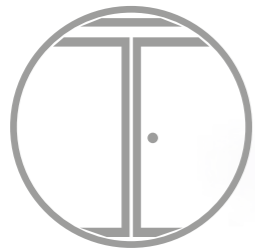
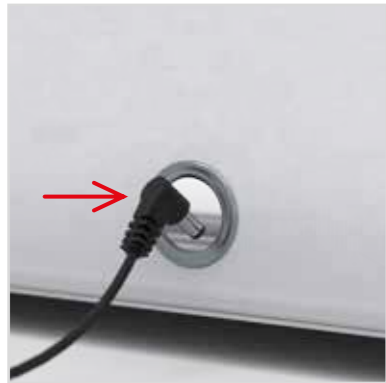

TÜRE / DOOR
S. 50 / P. 50



10.



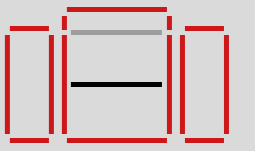
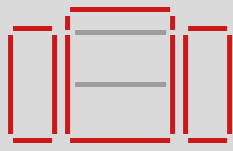

11.



12.



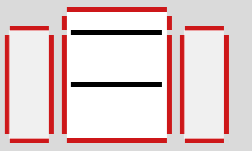
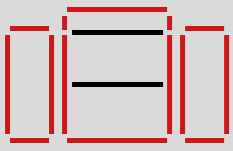

13.

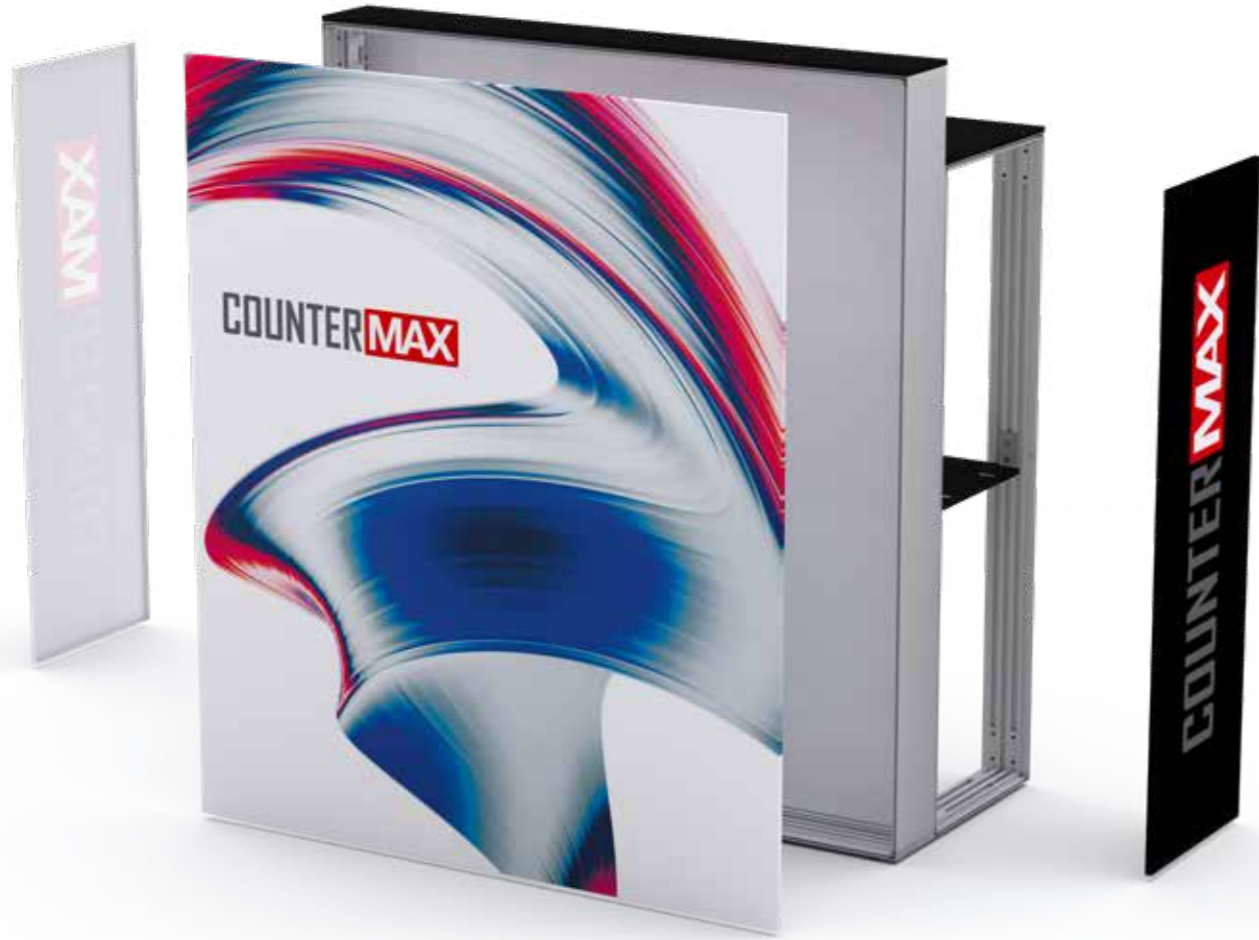

14.

