

AUFBAUANLEITUNG SET UP INSTRUCTION

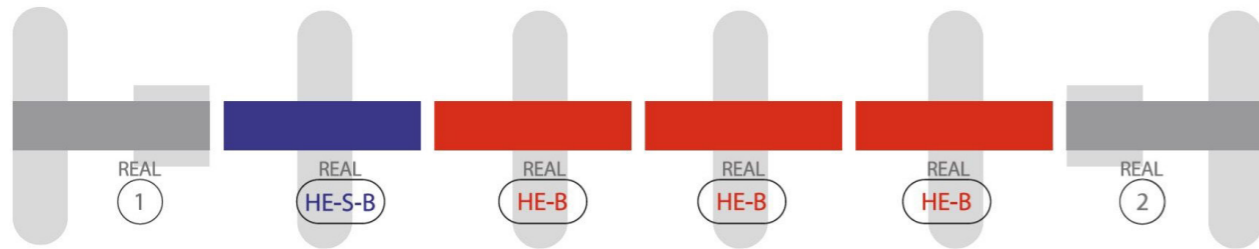

BIG LED UP

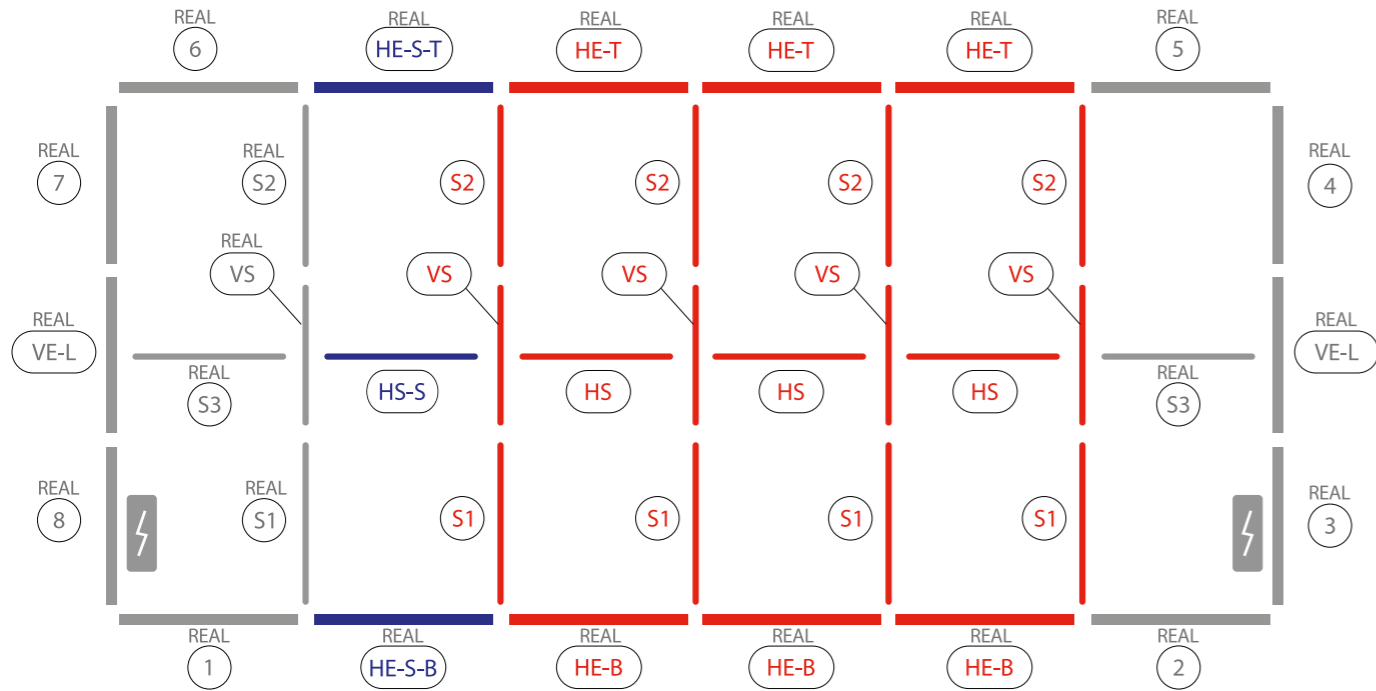

BASEPLATE PLACEMENT

1.

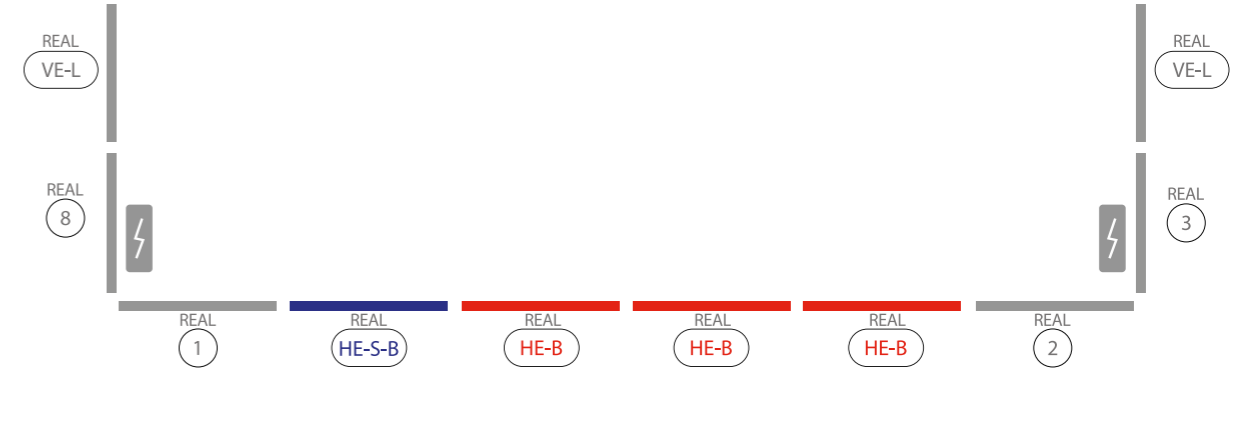

2.

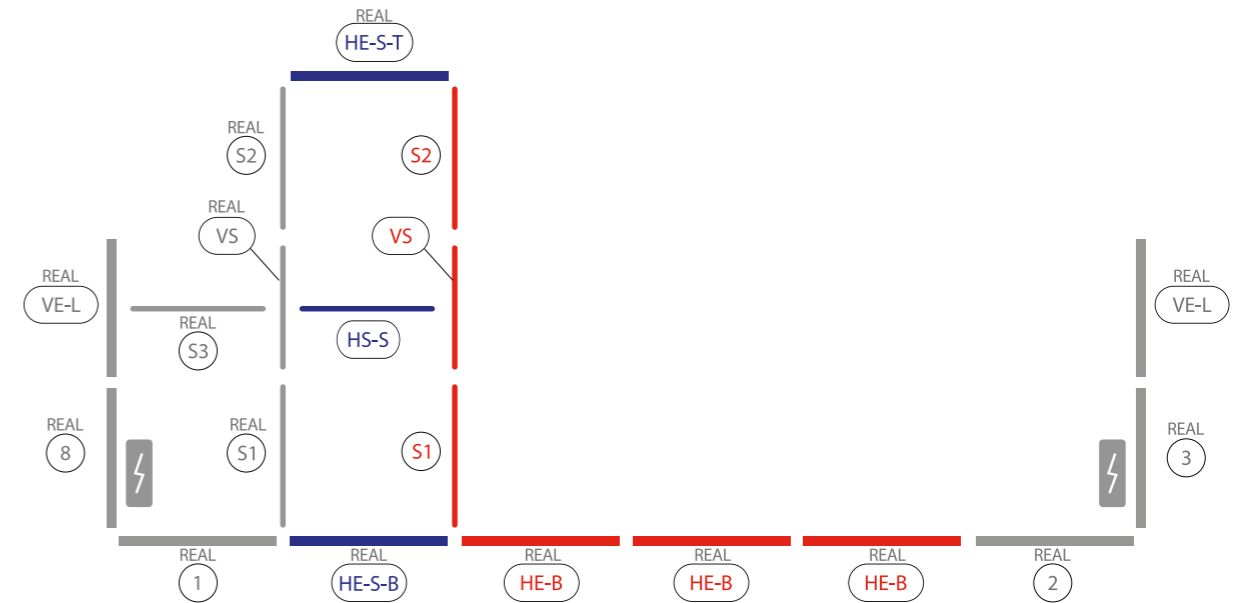

3.

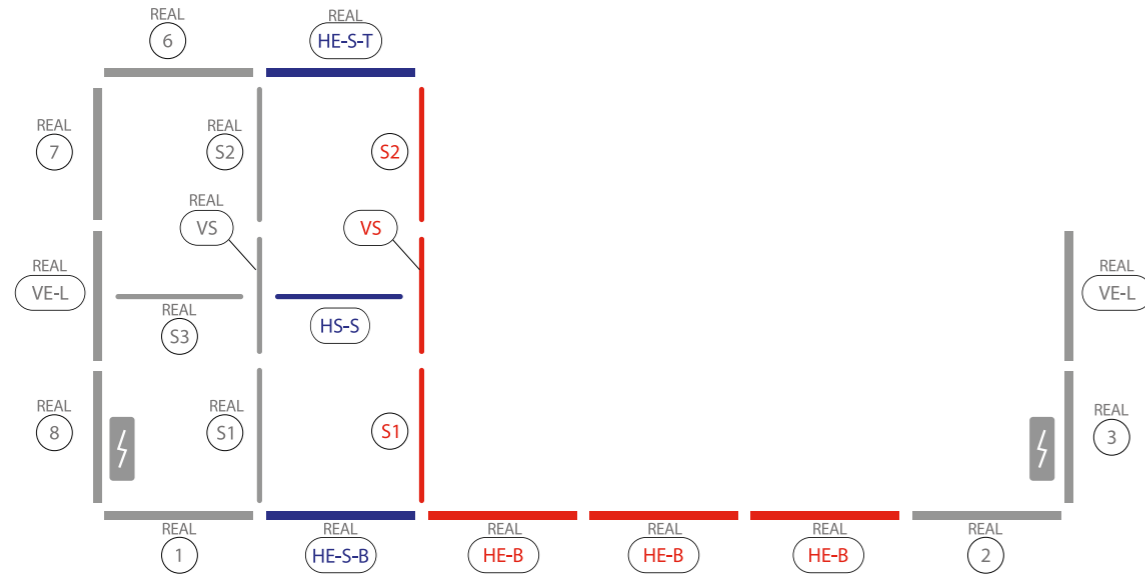

5.

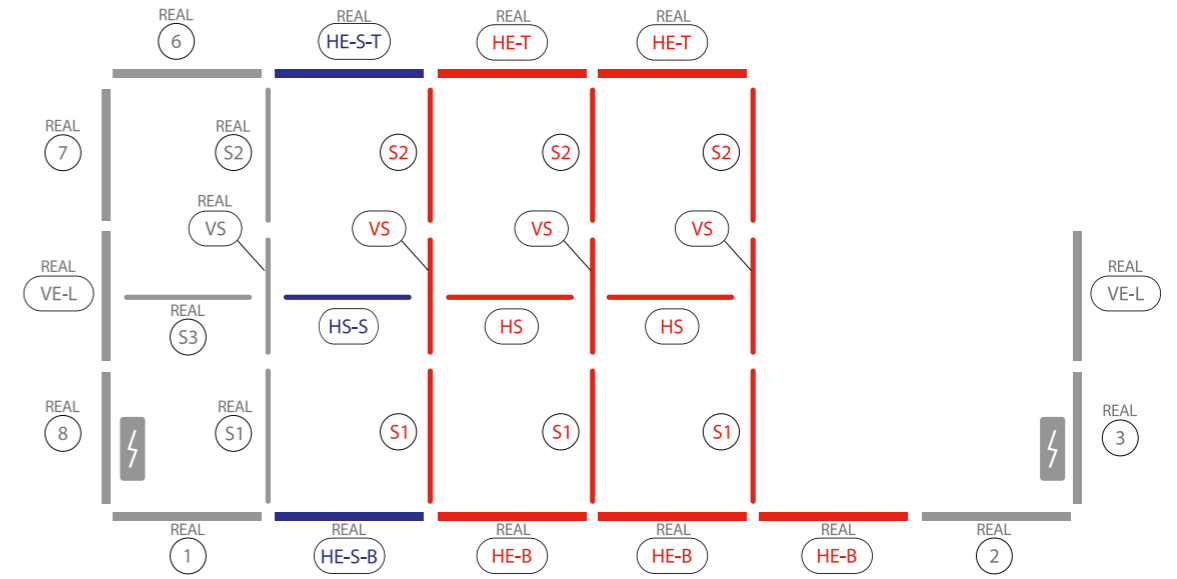

4.

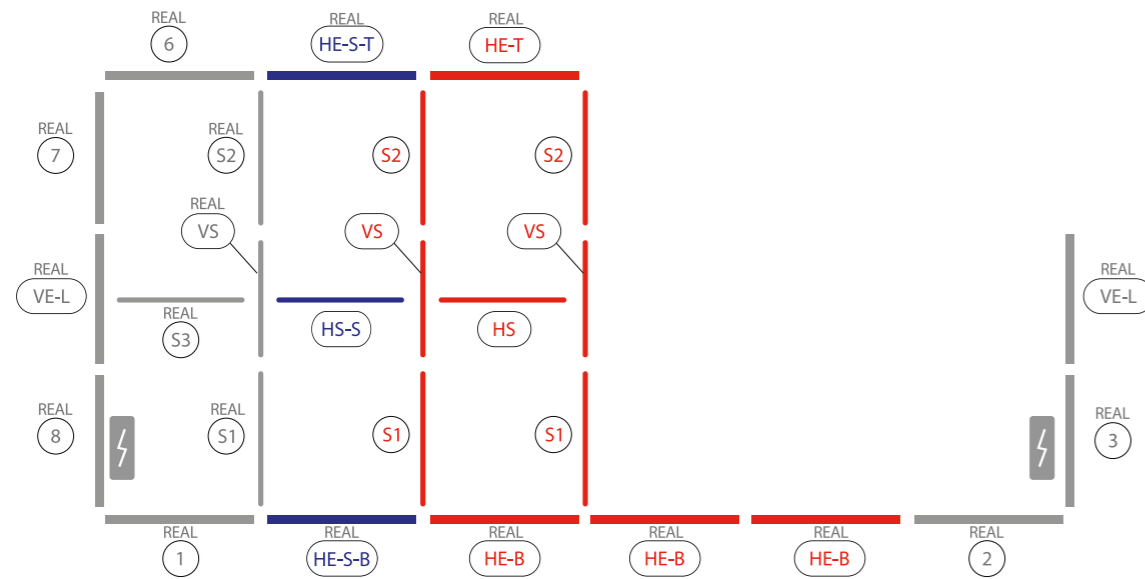

6.

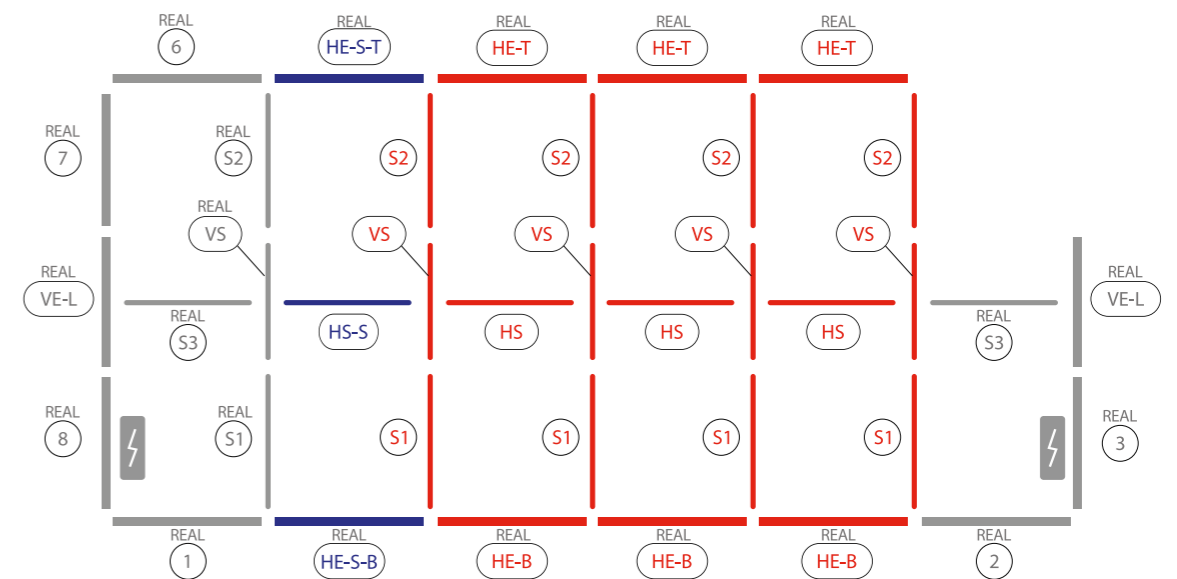

7.

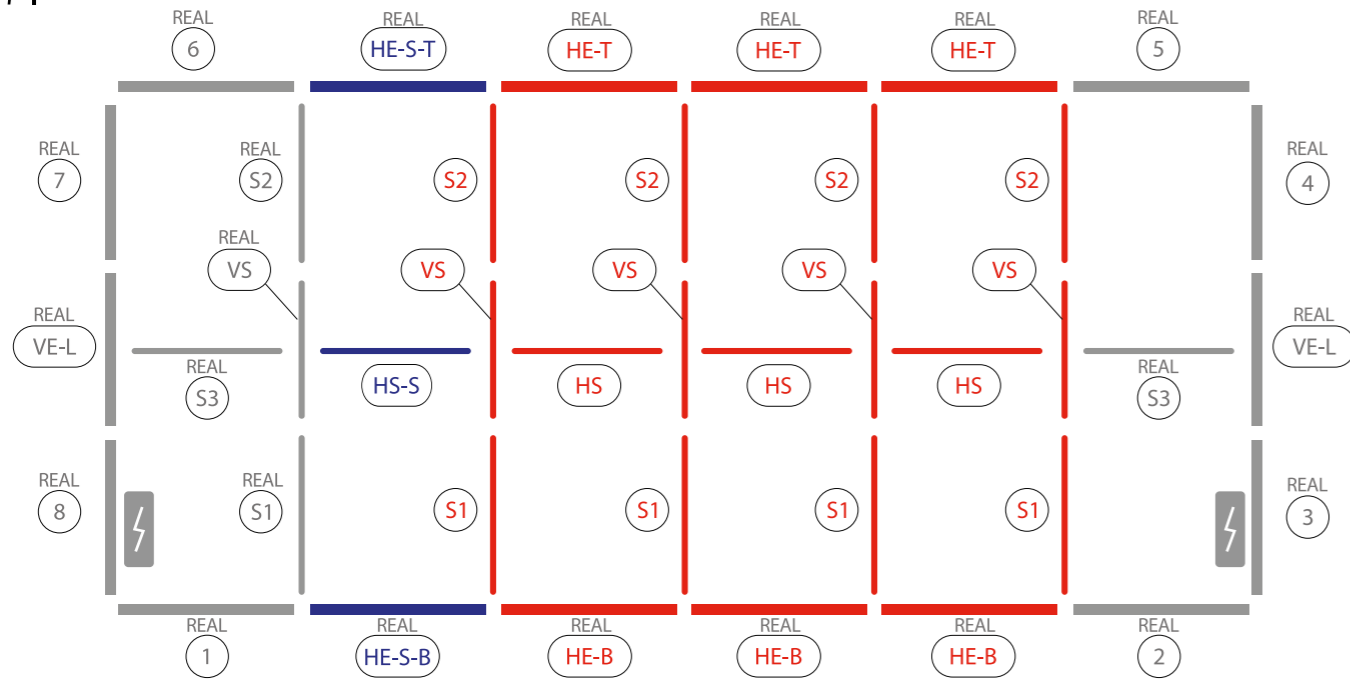

AUFBAUANLEITUNG SET UP INSTRUCTION

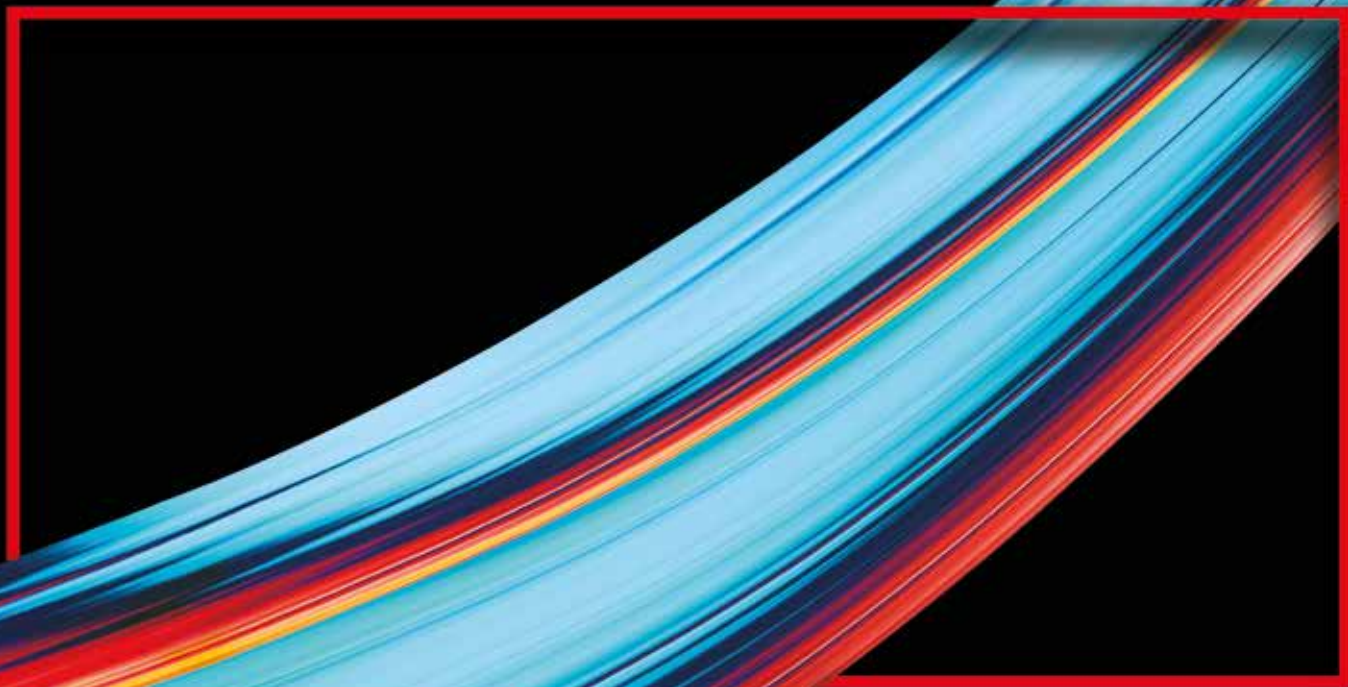

BIG LED UP

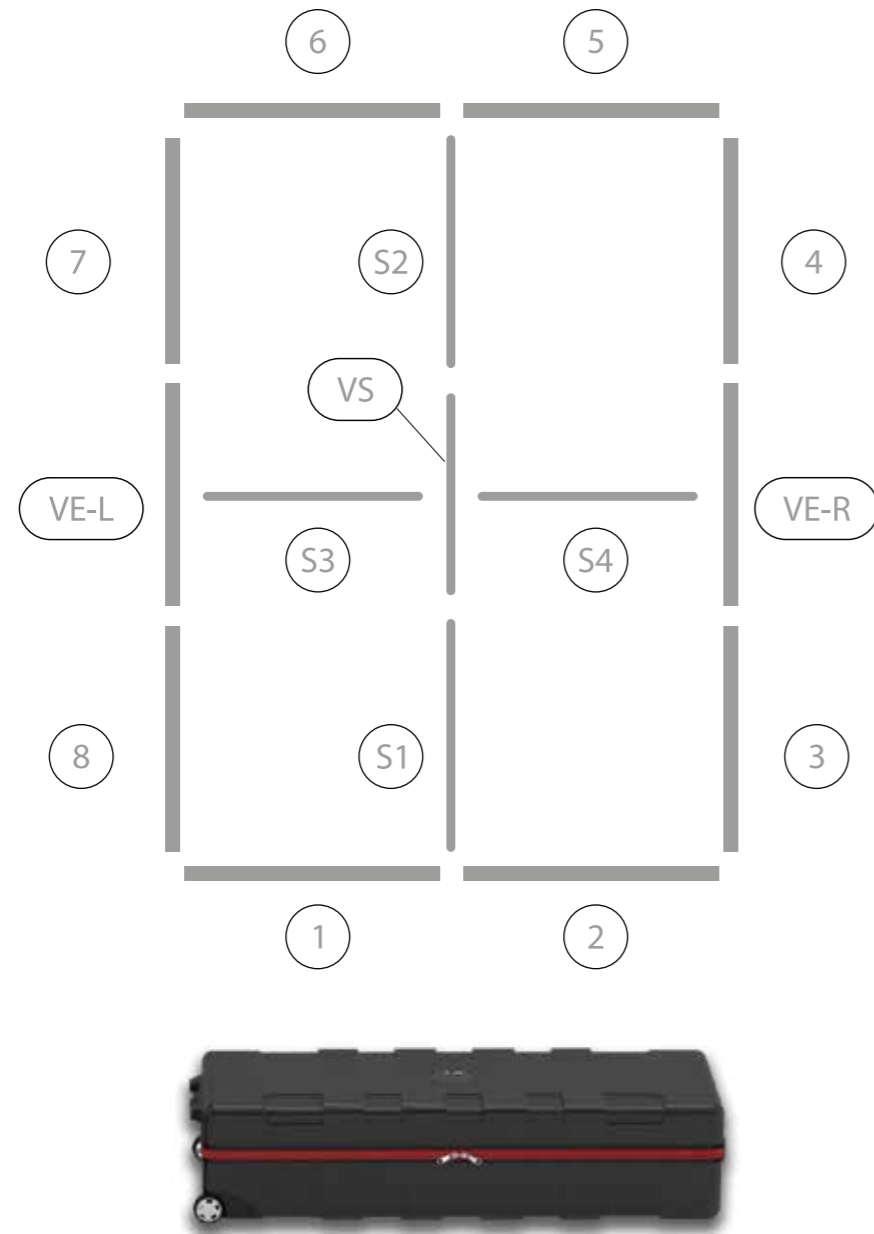

1.

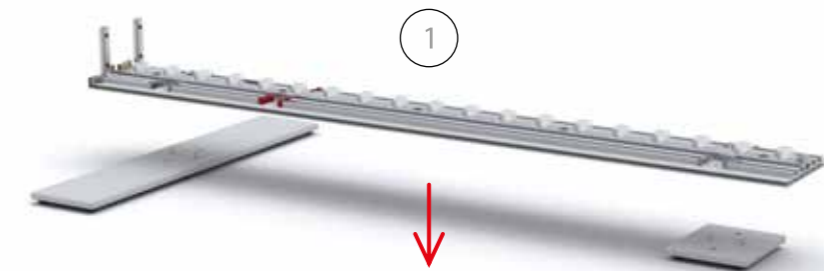

2.

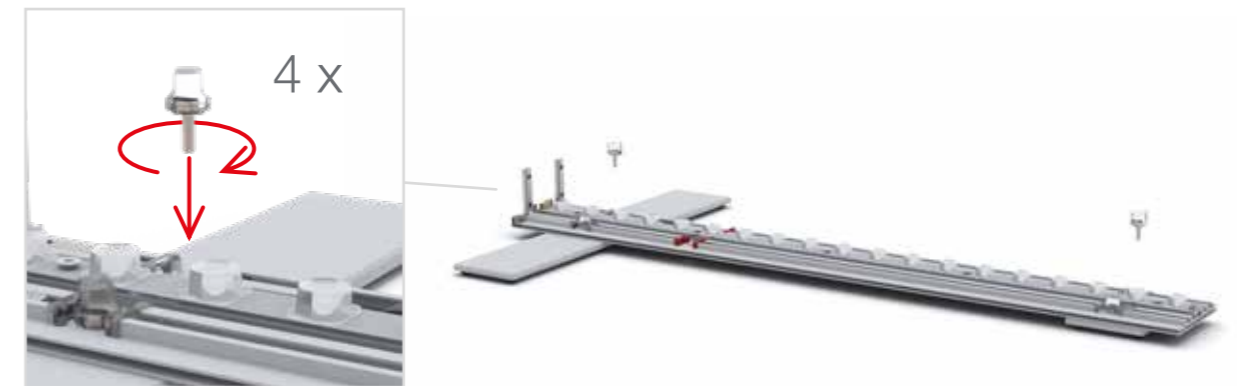

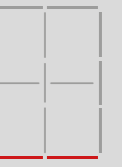
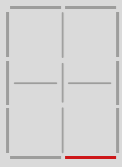

3.

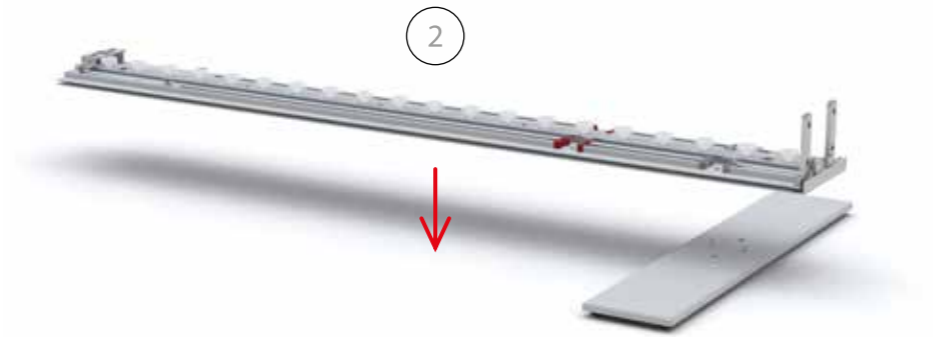

5.



4.



6.

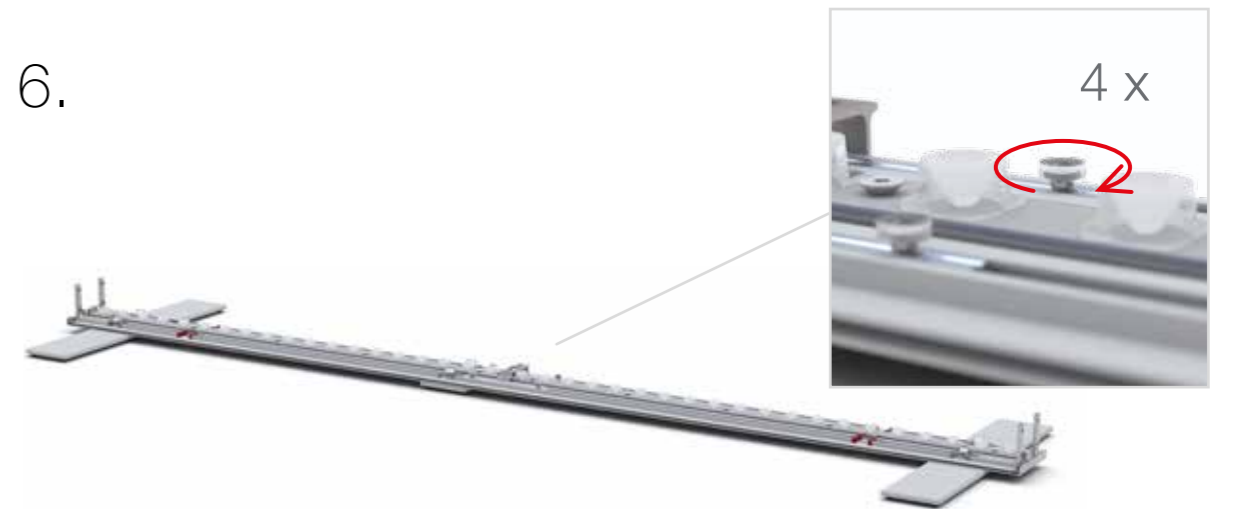

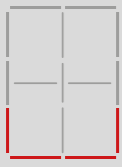

7.

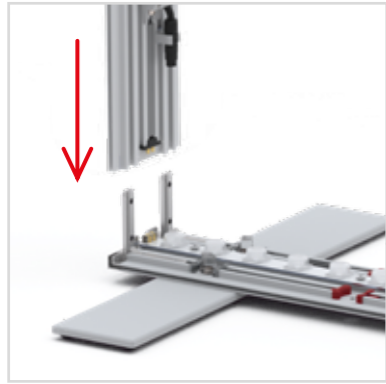

8.

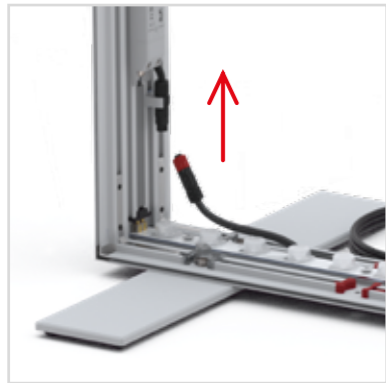

9.



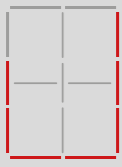

10.

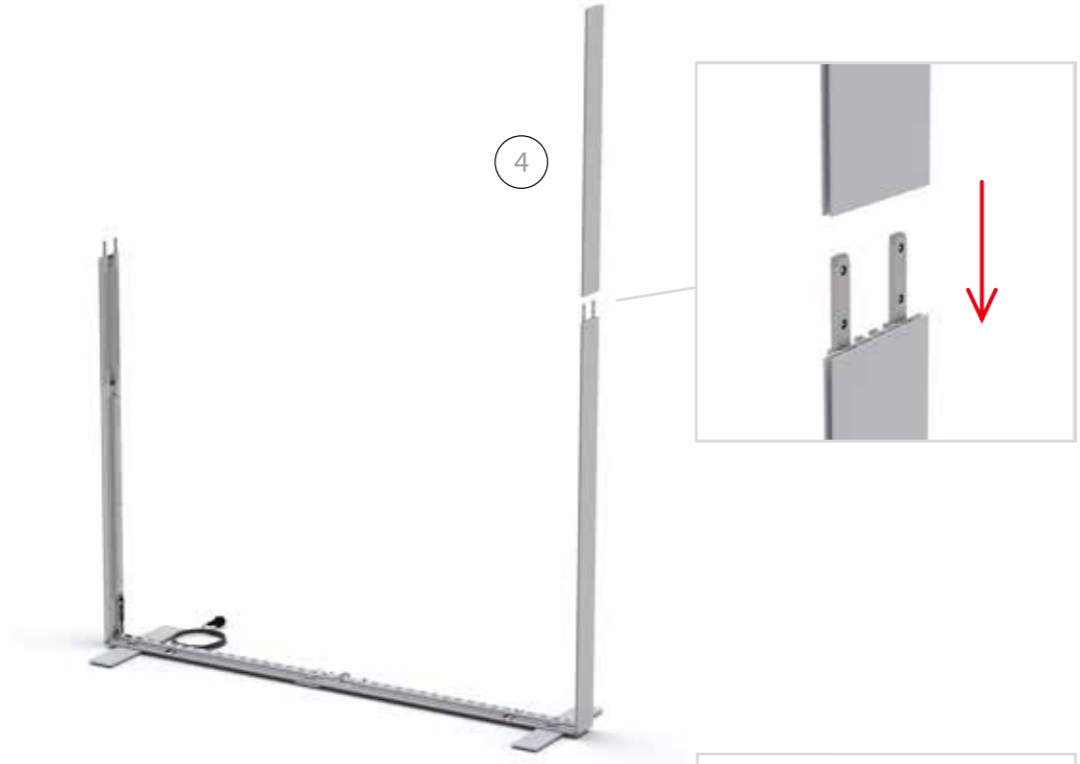

11.

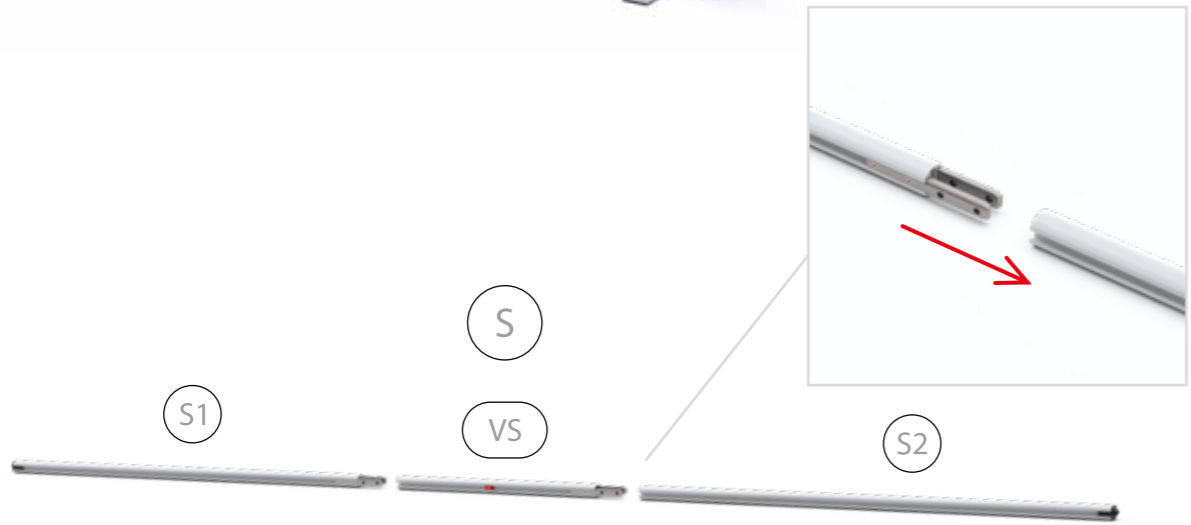

12.



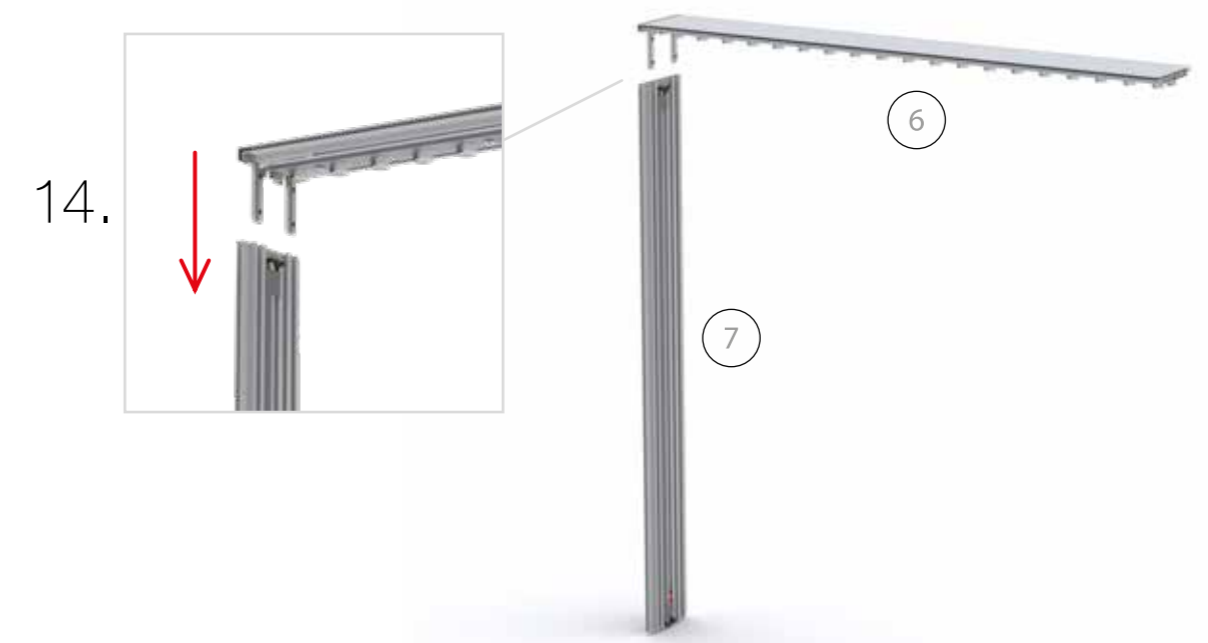
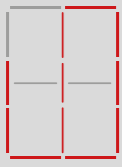

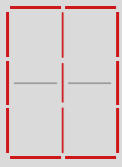

15.

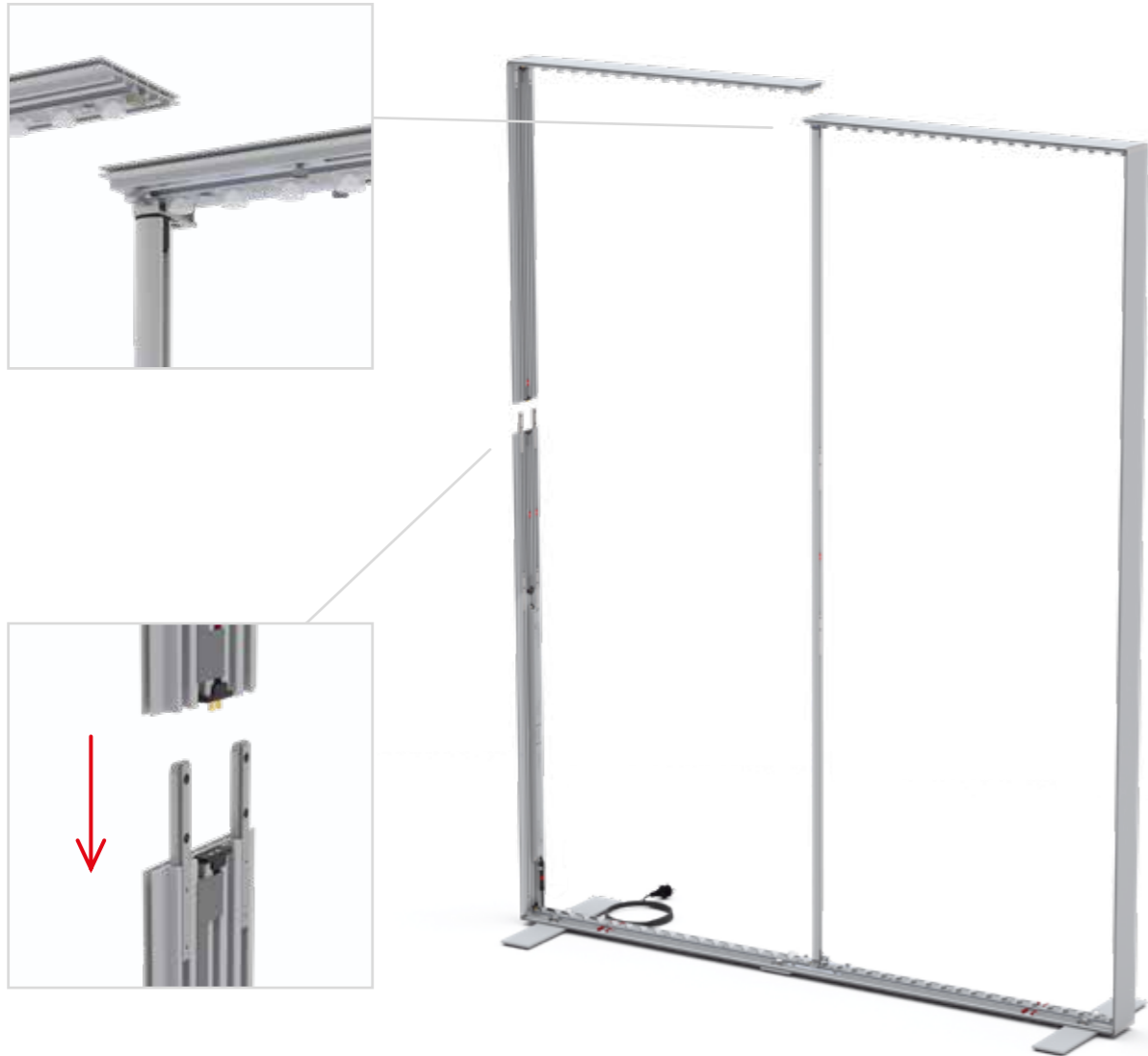

16.



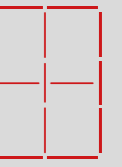
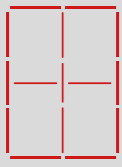

17.

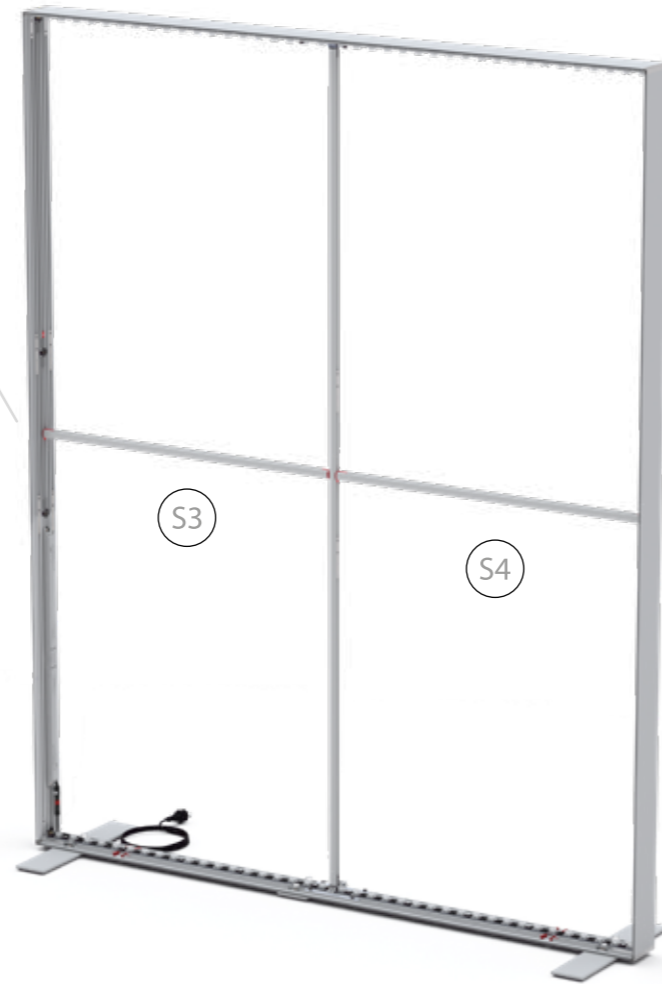
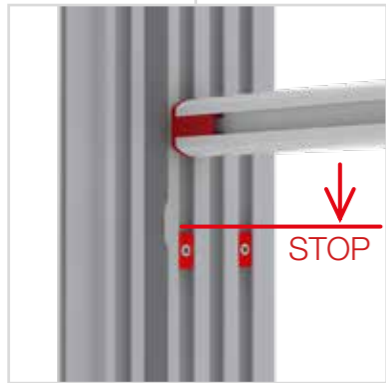

18.



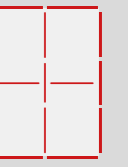
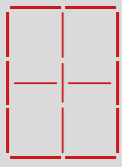

19.

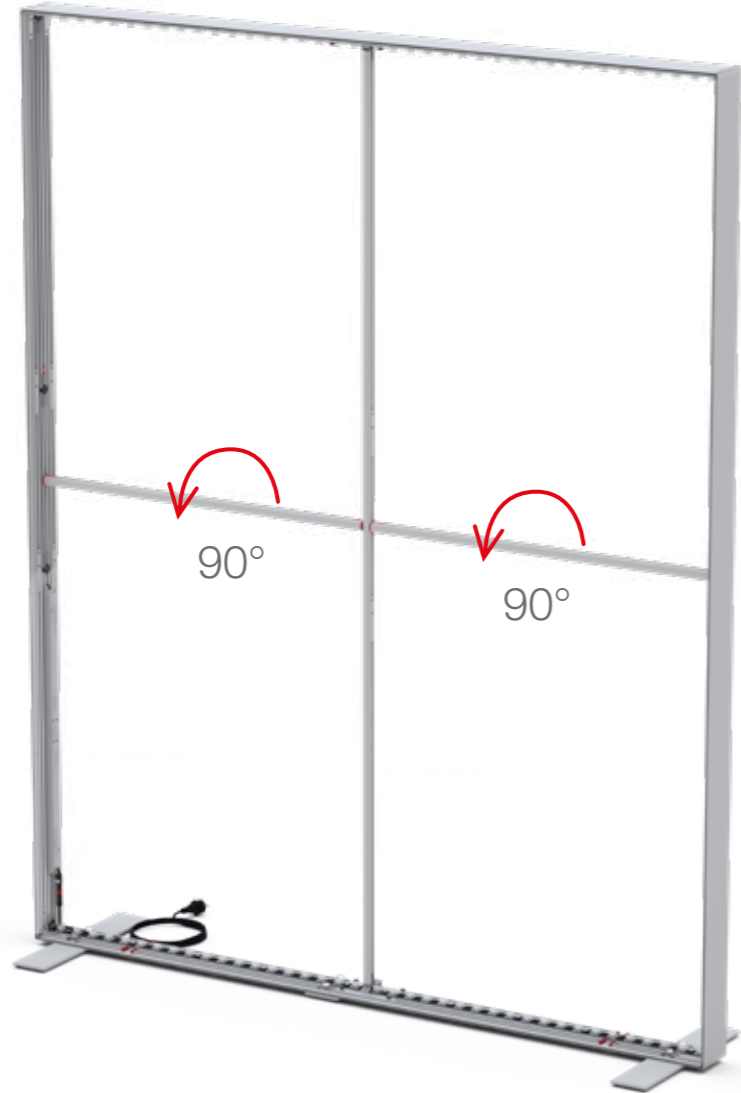

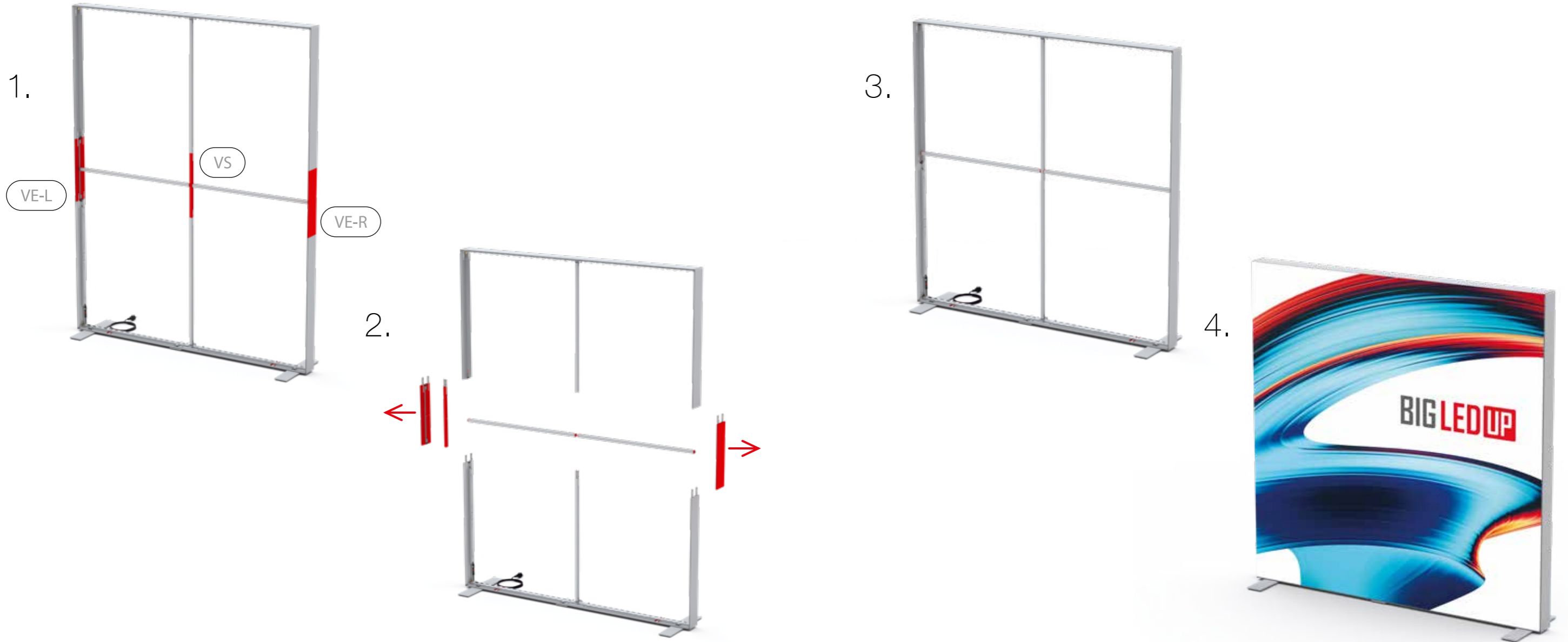

ZUBEHÖR
ACCESSORIES



BIG LED UP

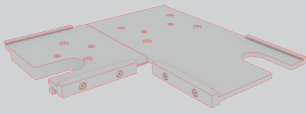

BLUP-conn-90

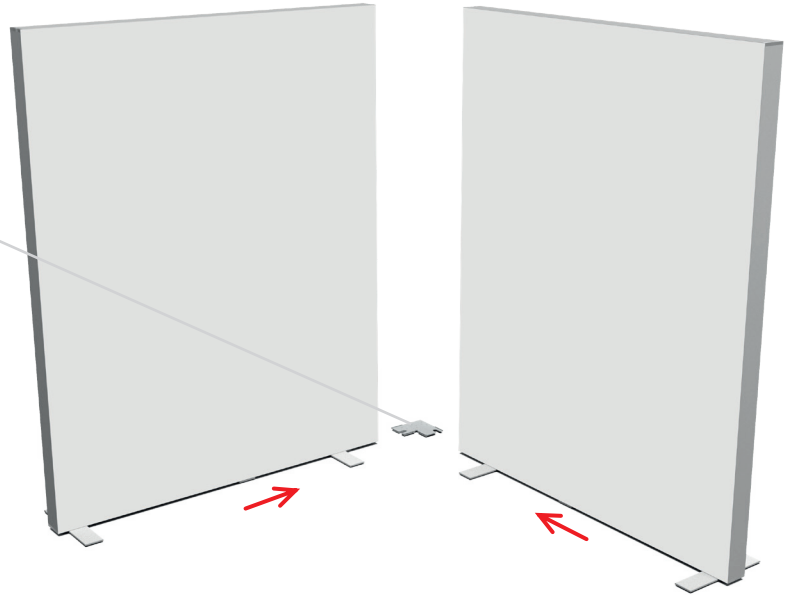

1.

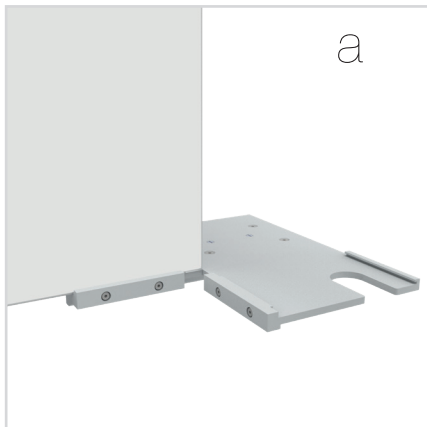

a

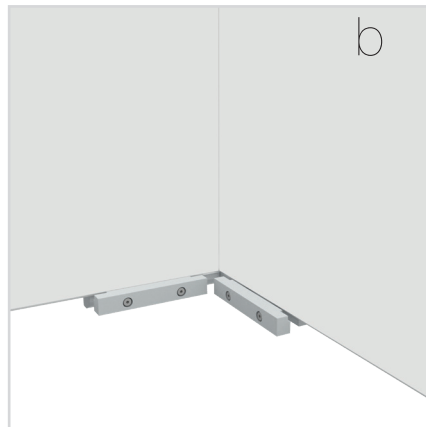

b

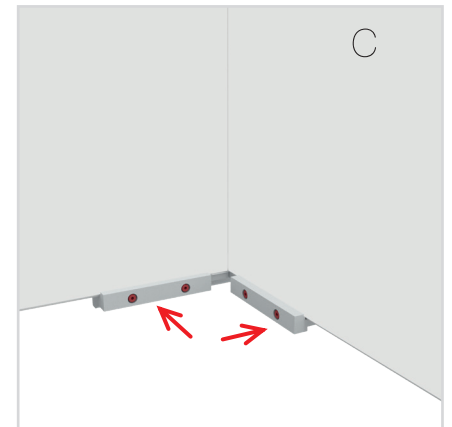

c

ECK KLEMME/ CORNER CLAMP

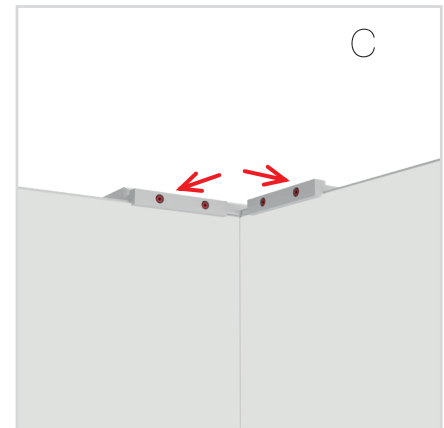
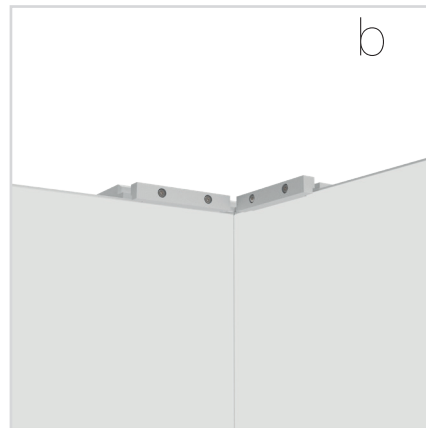
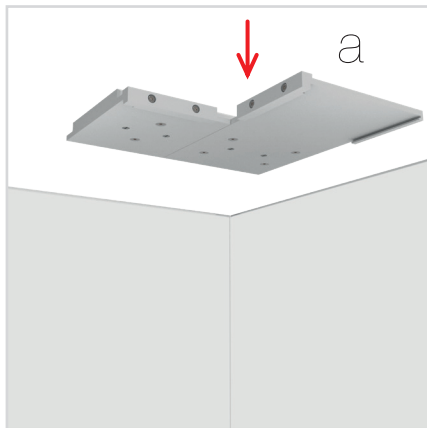
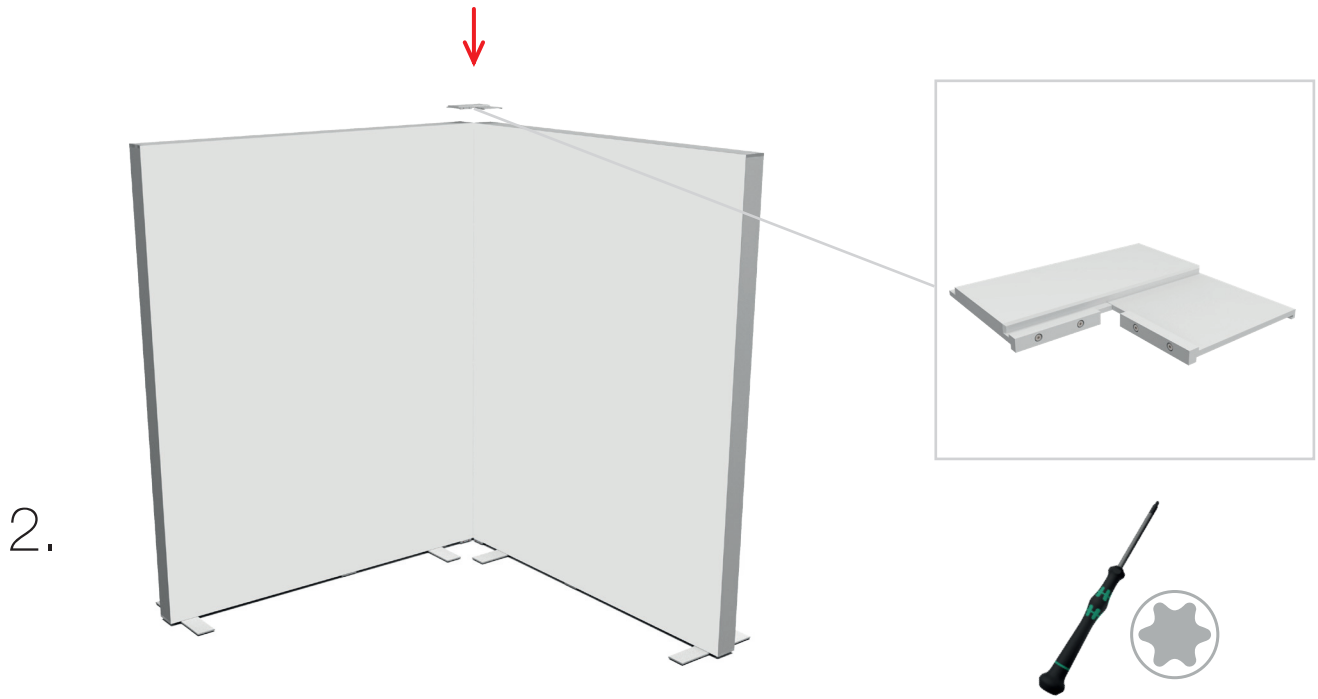



AUFBAUANLEITUNG SETUP INSTRUCTION



COUNTER

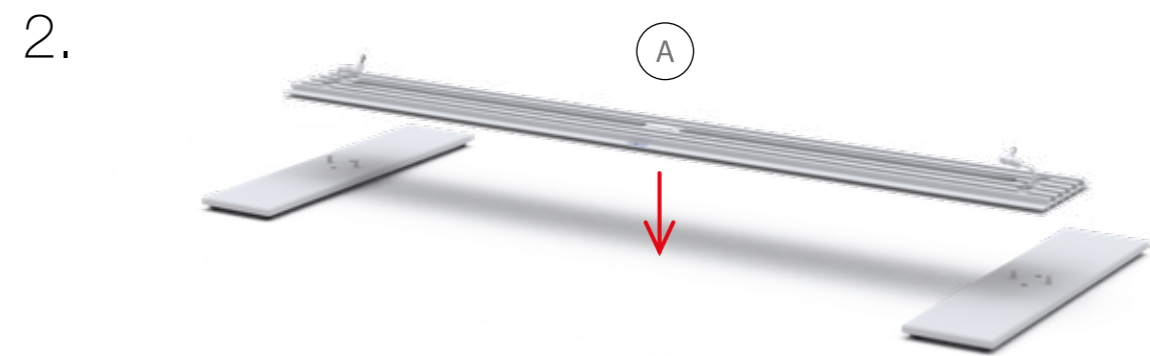
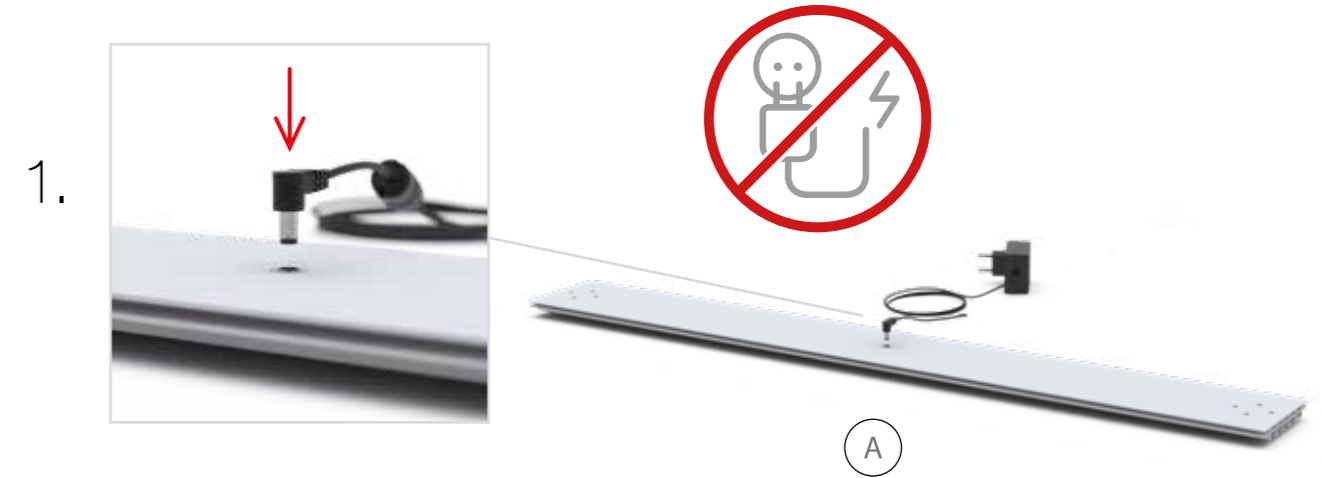

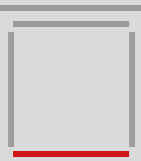

3.

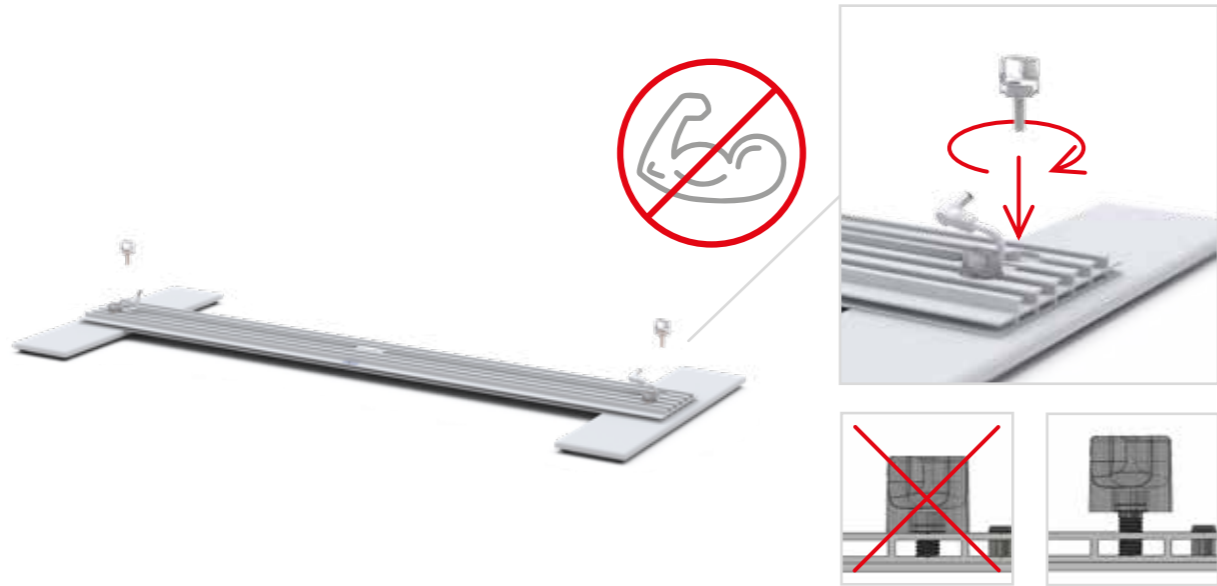

4.

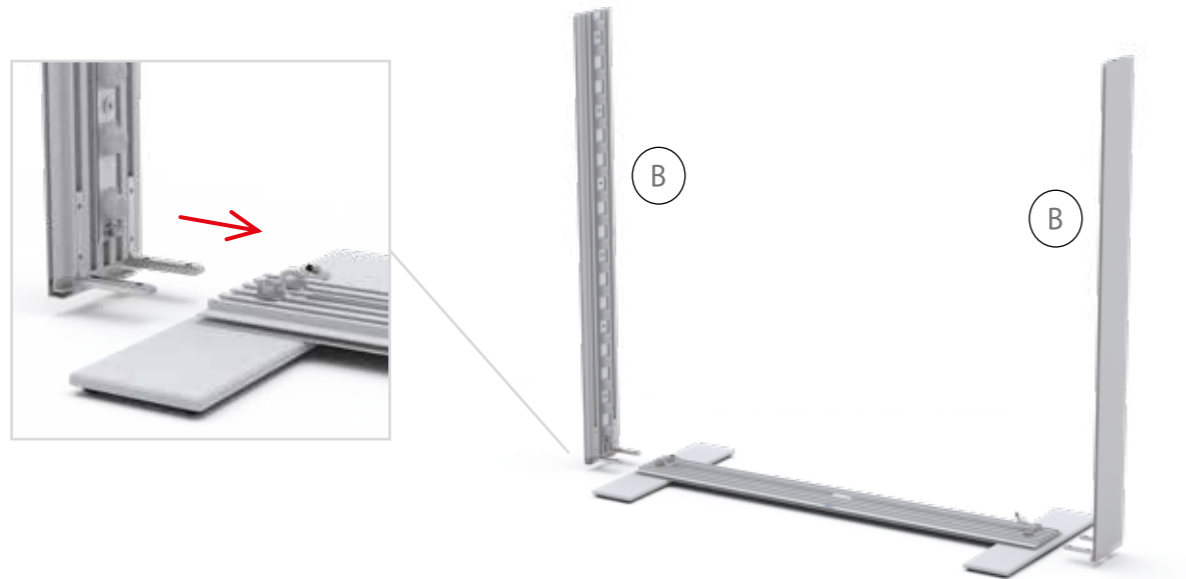

5.



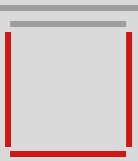

6.



7.



8.





9.



10.

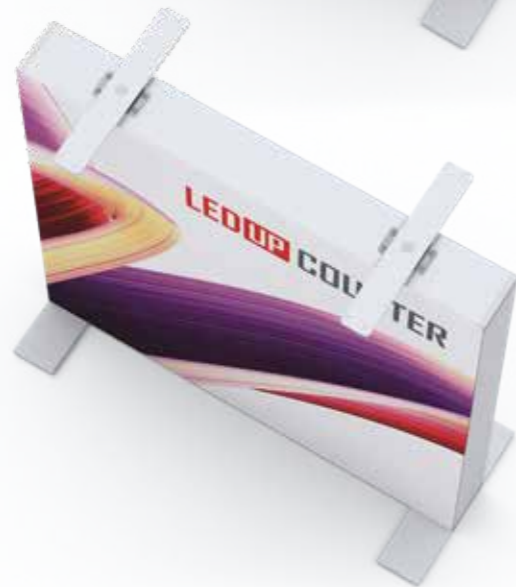

11.



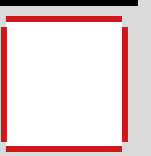
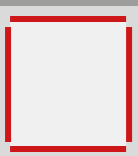

12.

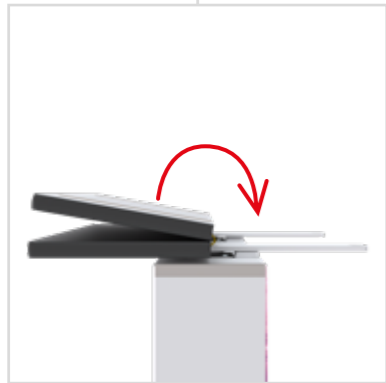

13.

