

AUFBAUANLEITUNG SET UP INSTRUCTION

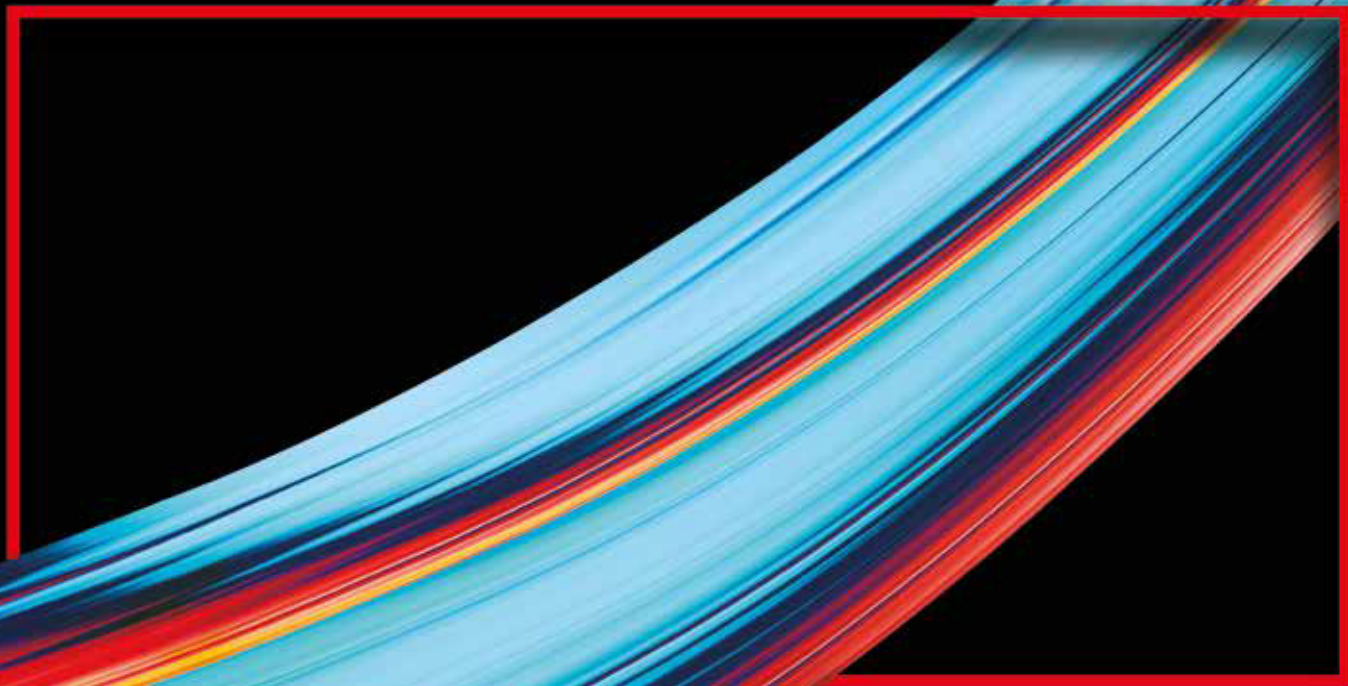

BIG LED UP

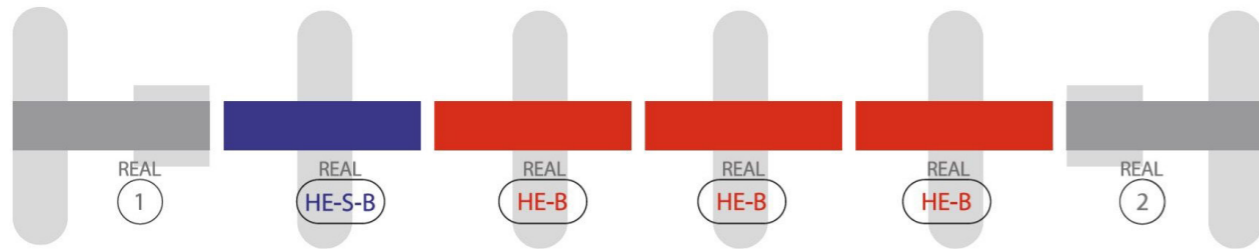
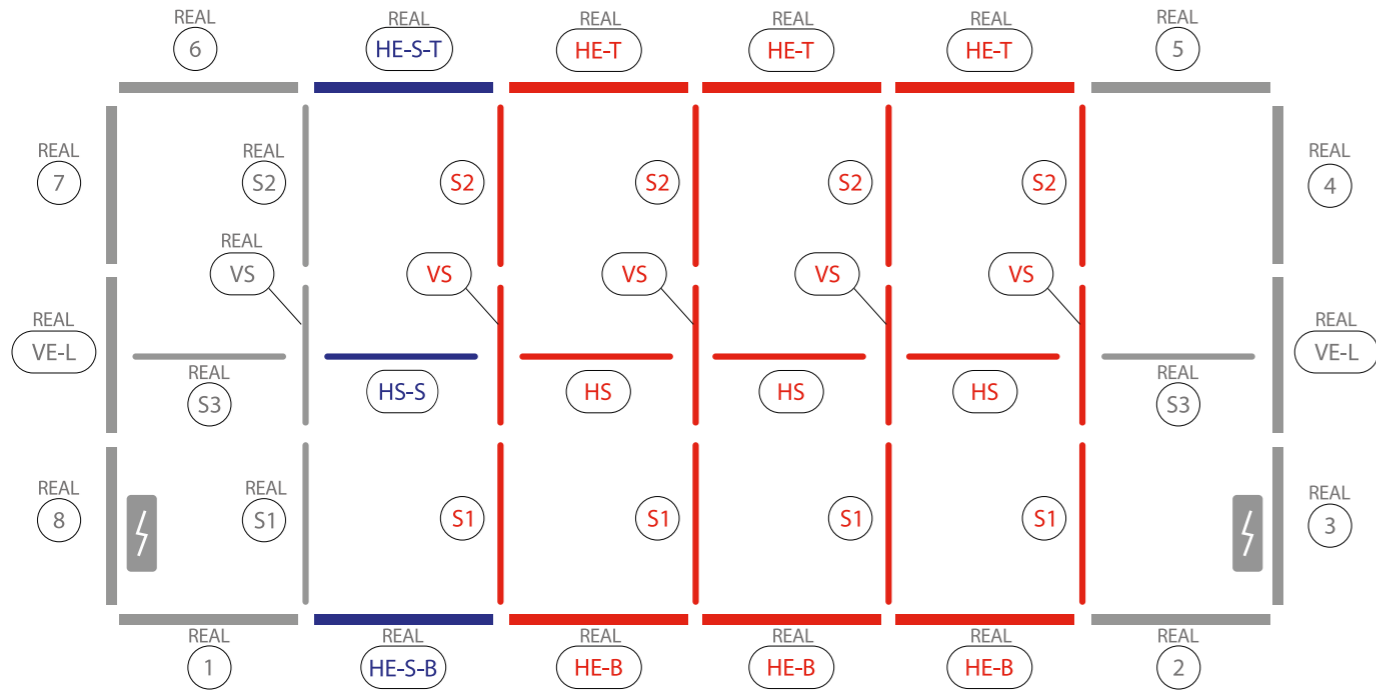

BASEPLATE PLACEMENT

1.



2.

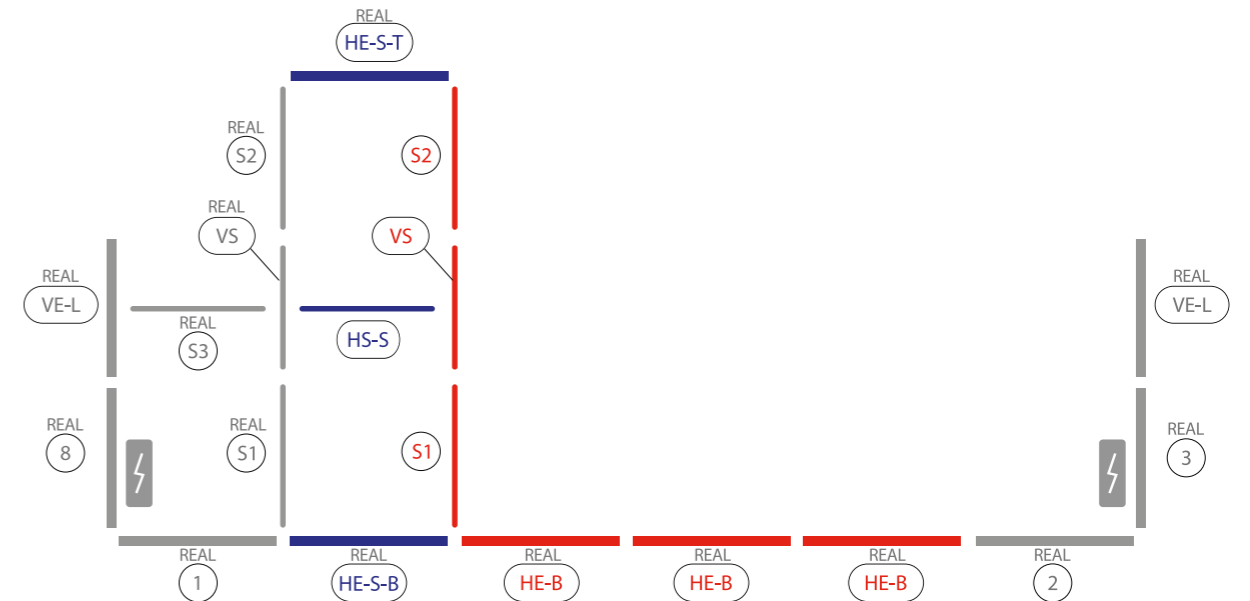

3.

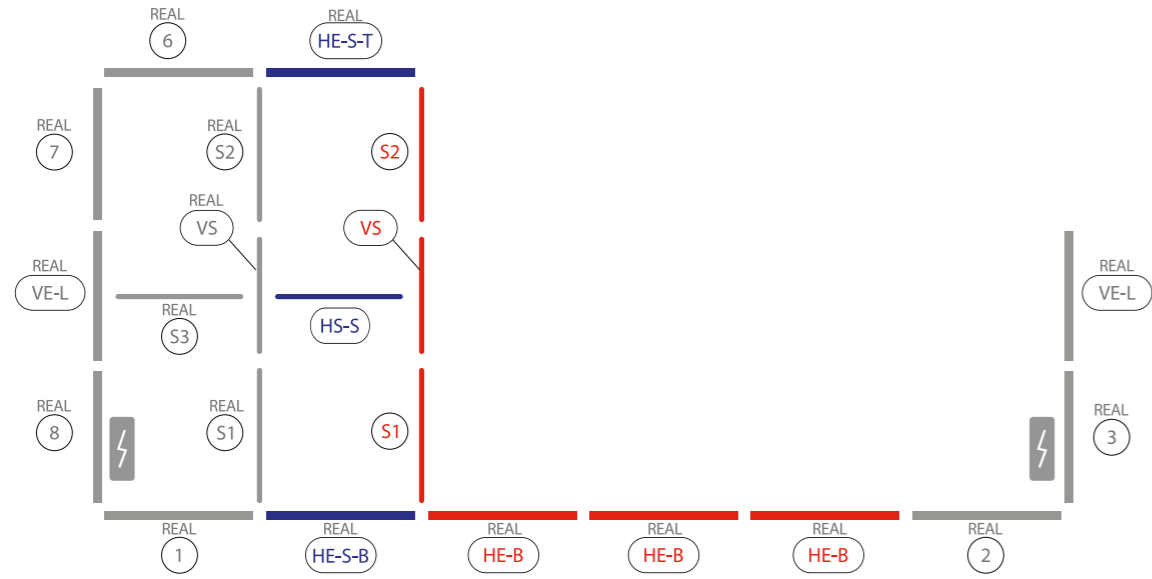

5.

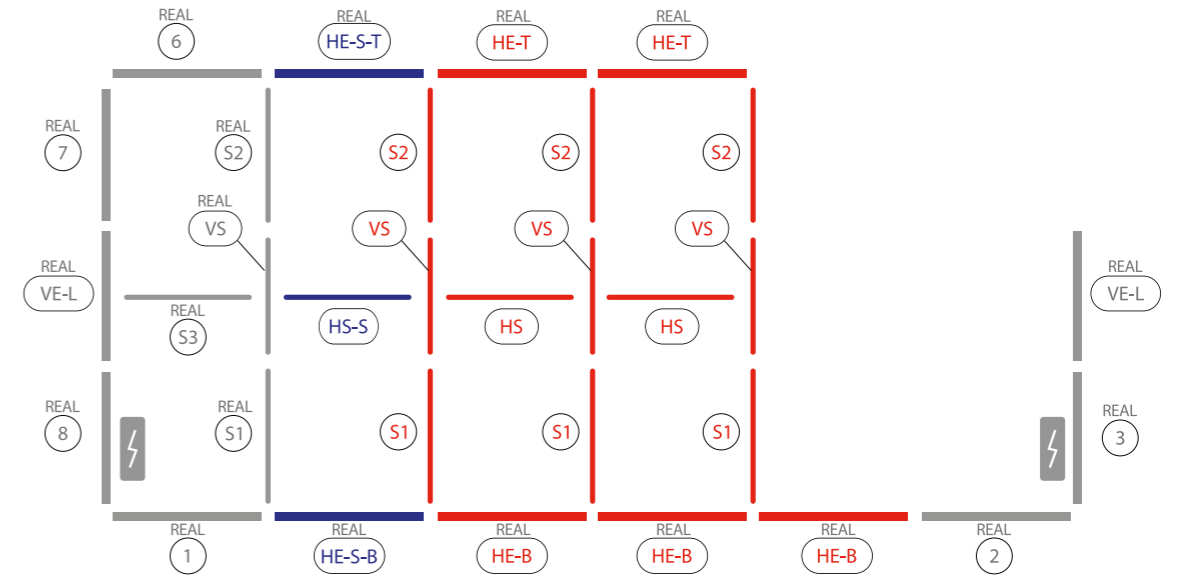

4.

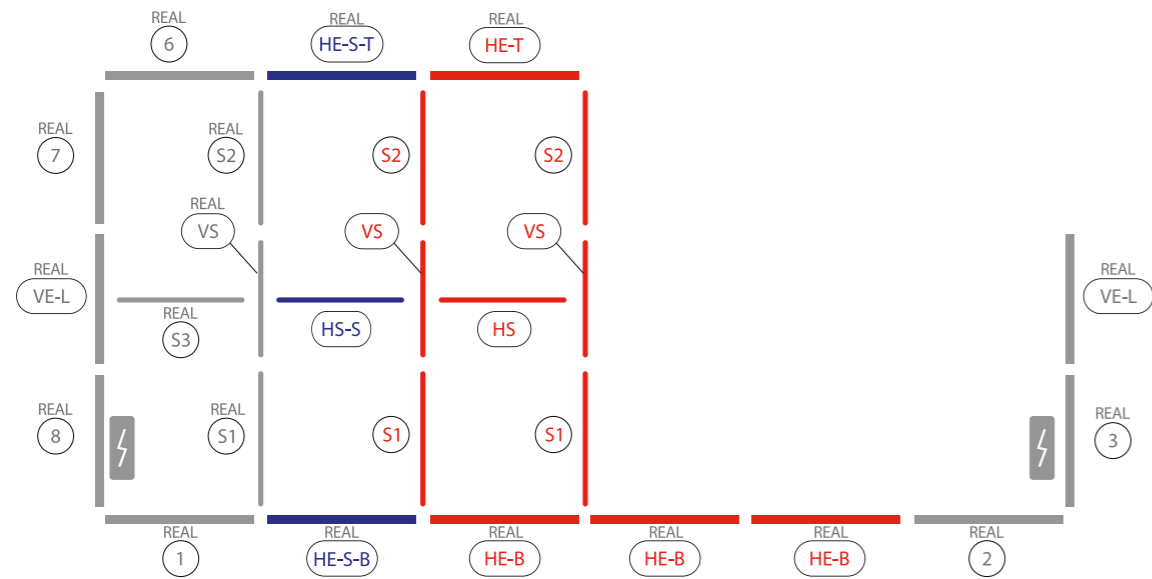

6.

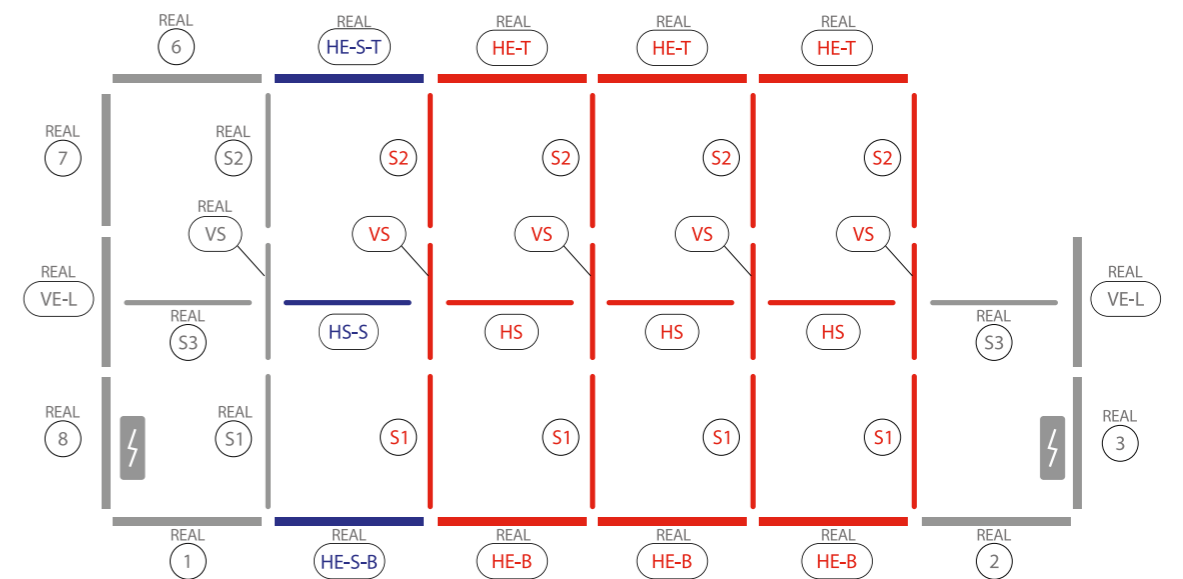

7.

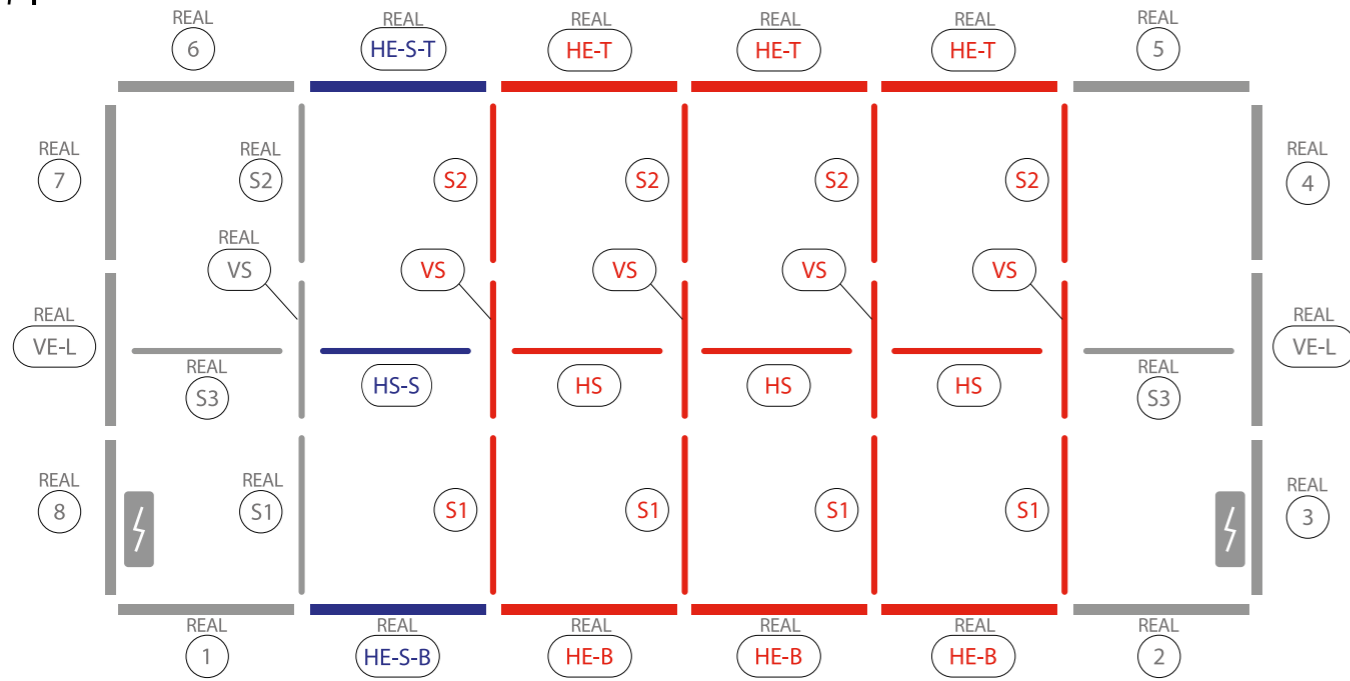

BIG LED UP

AUFBAUANLEITUNG SET UP INSTRUCTION

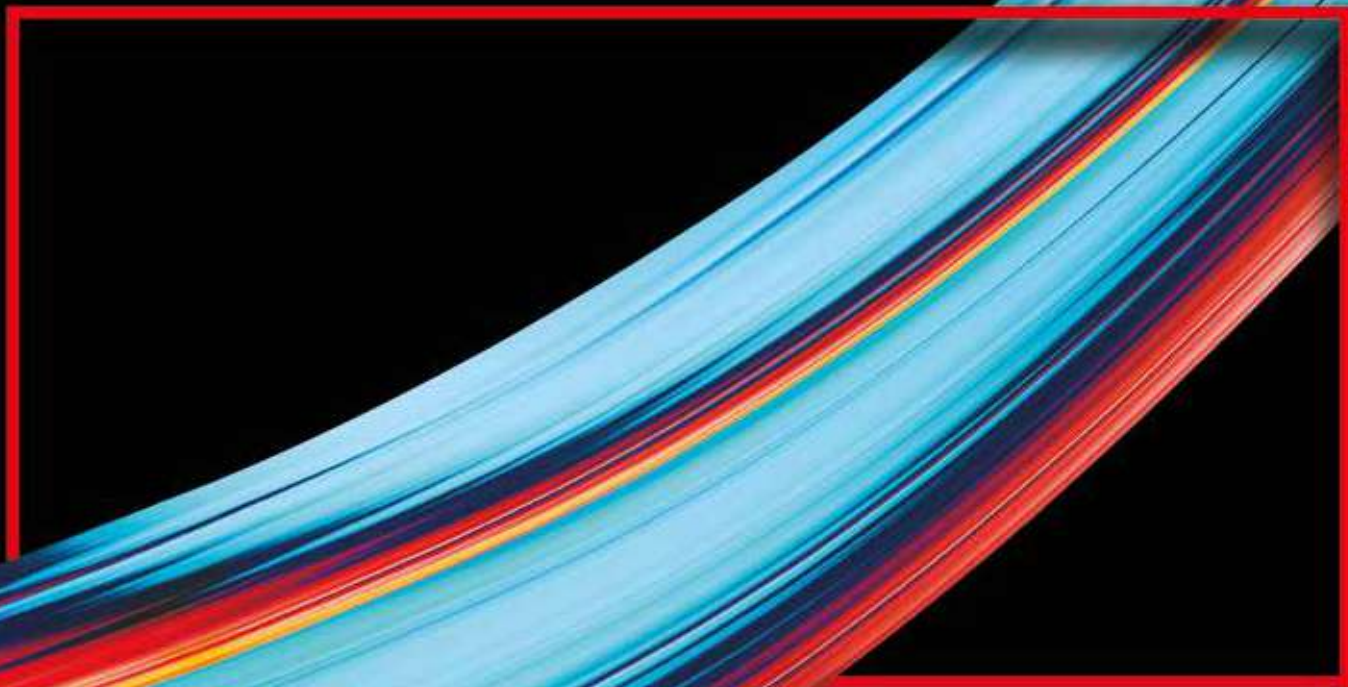

BIG LED UP

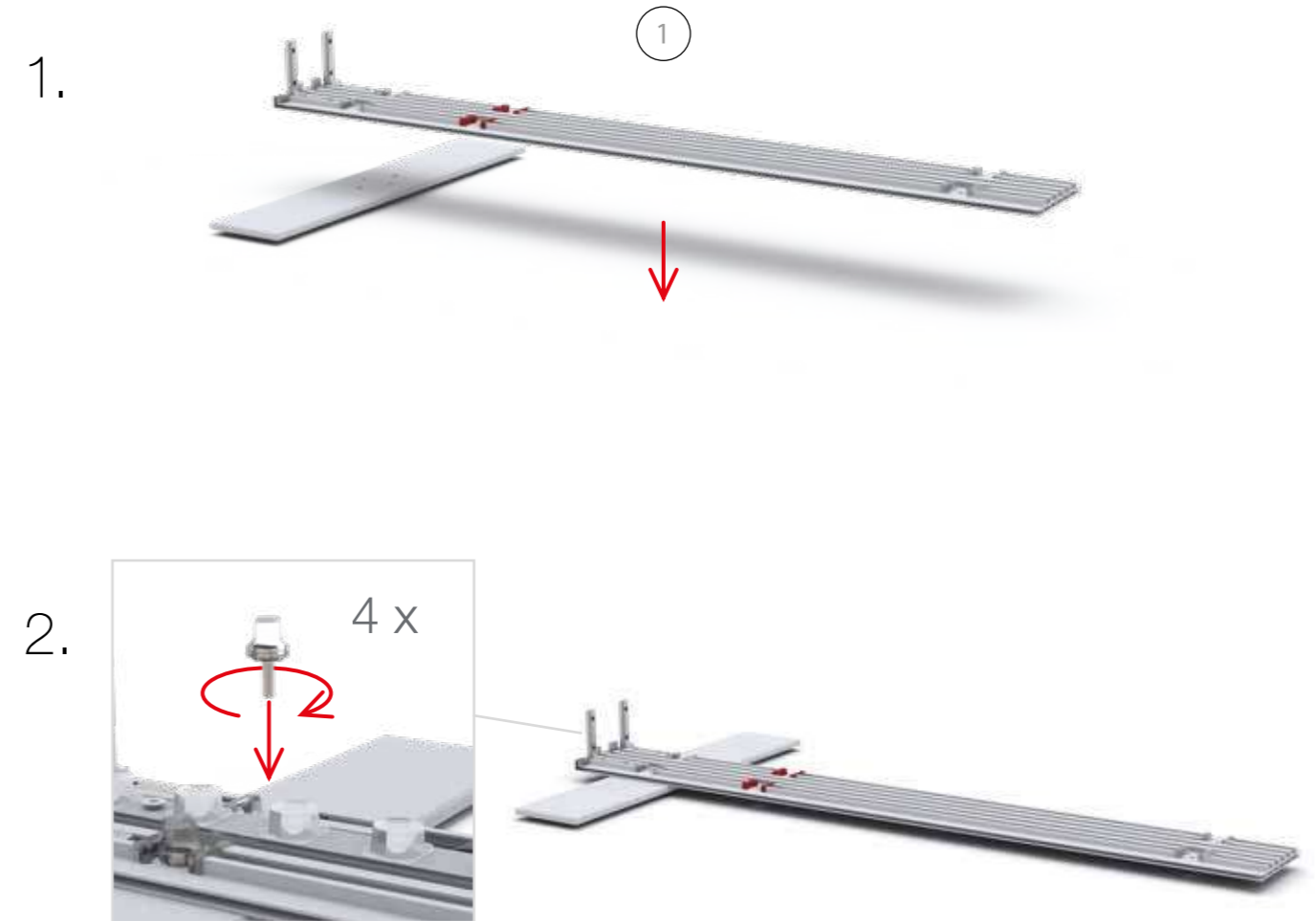
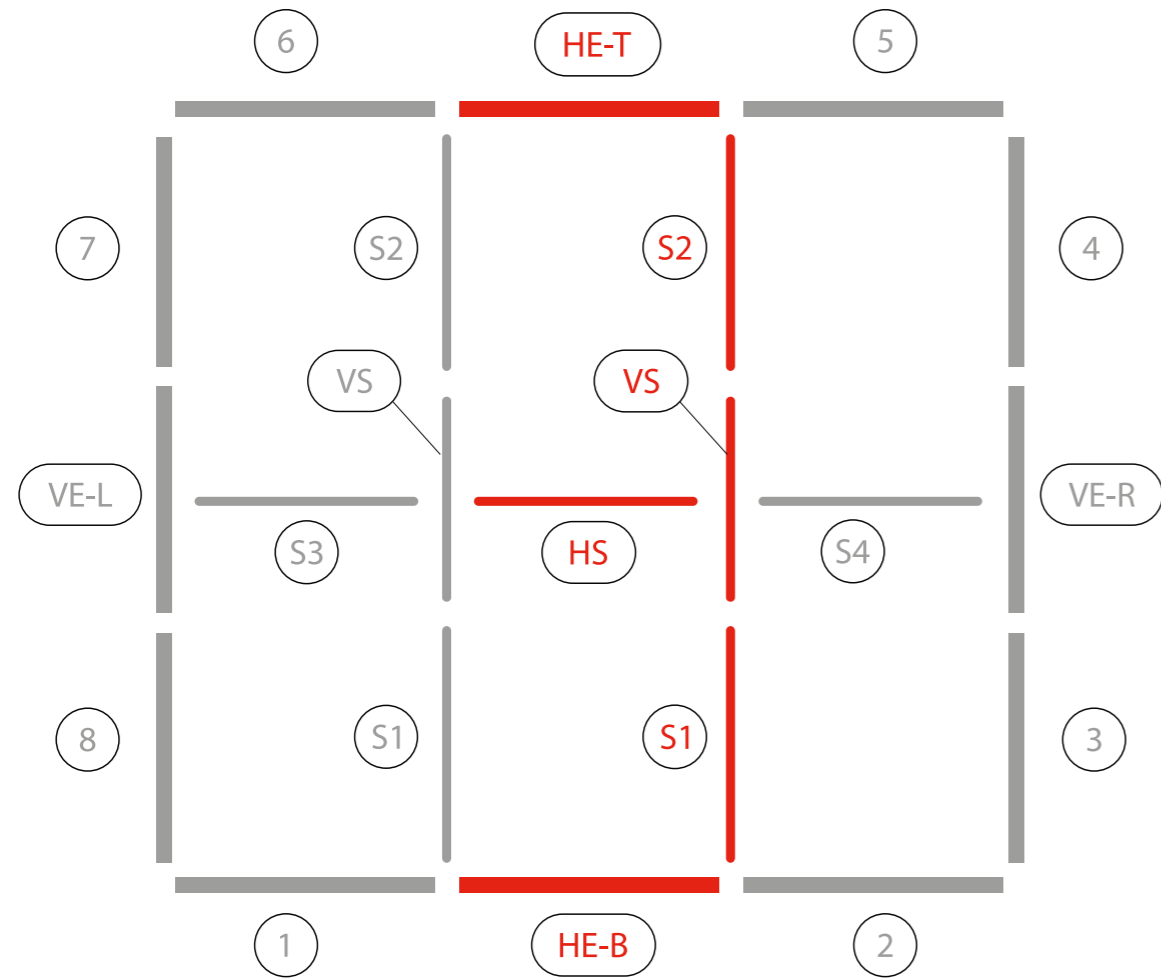

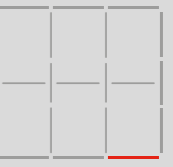
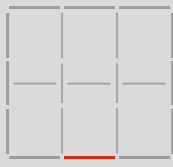

3.



5.



4.



6.



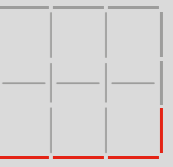
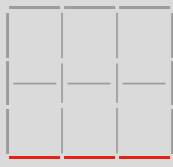

7.

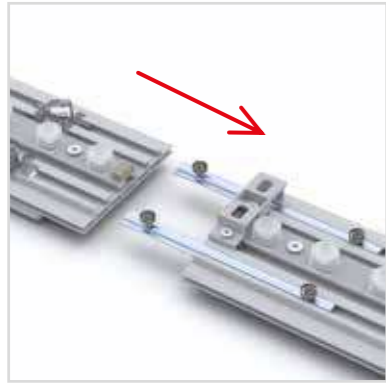

9.



8.

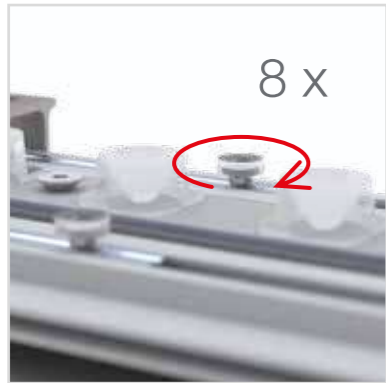

10.

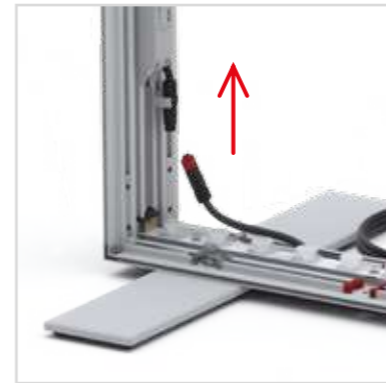

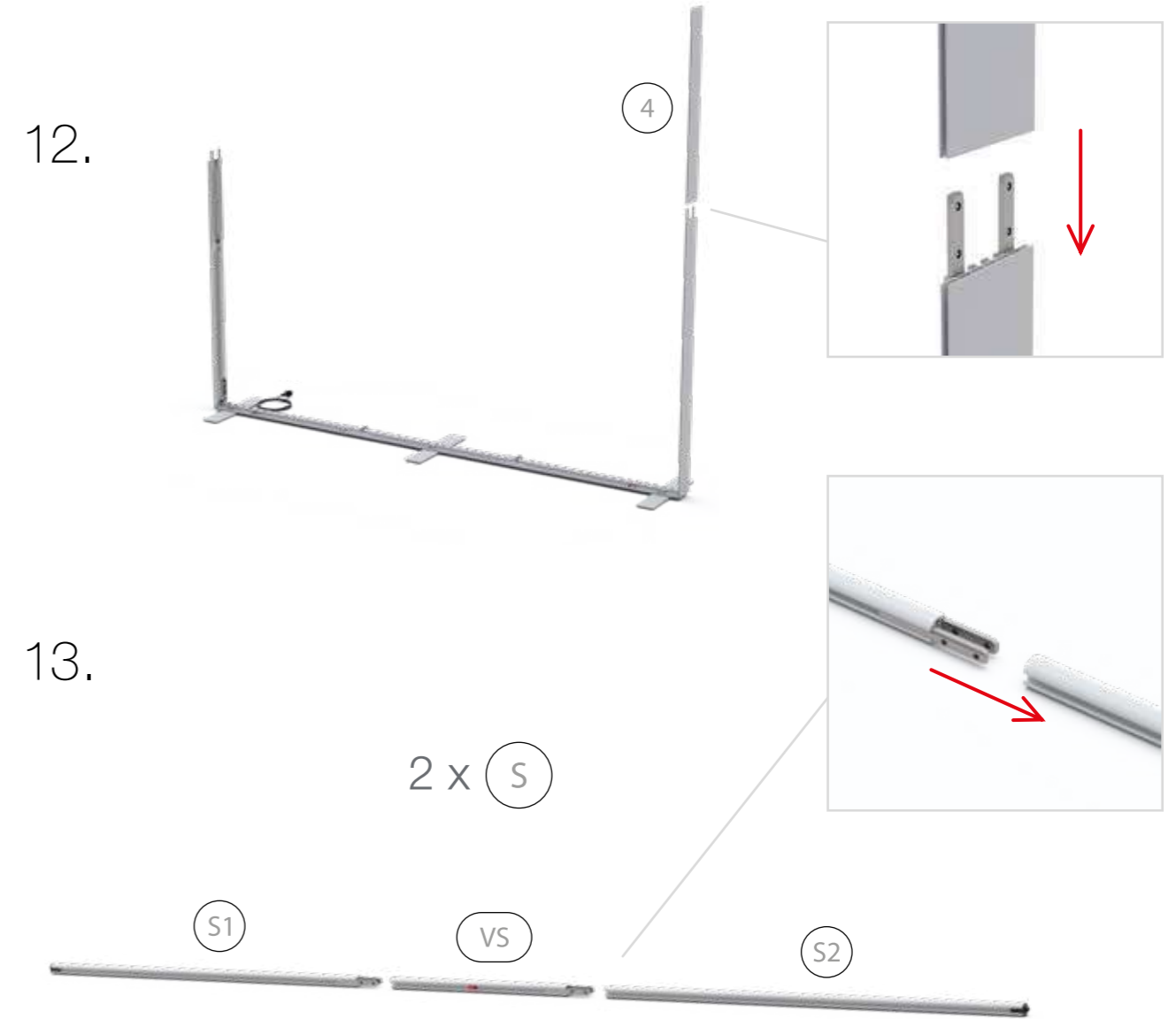
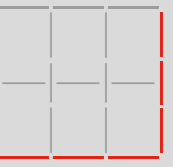
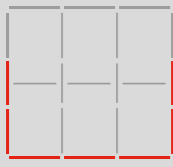

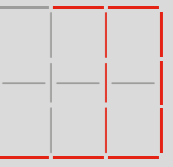
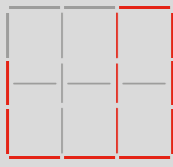

14.

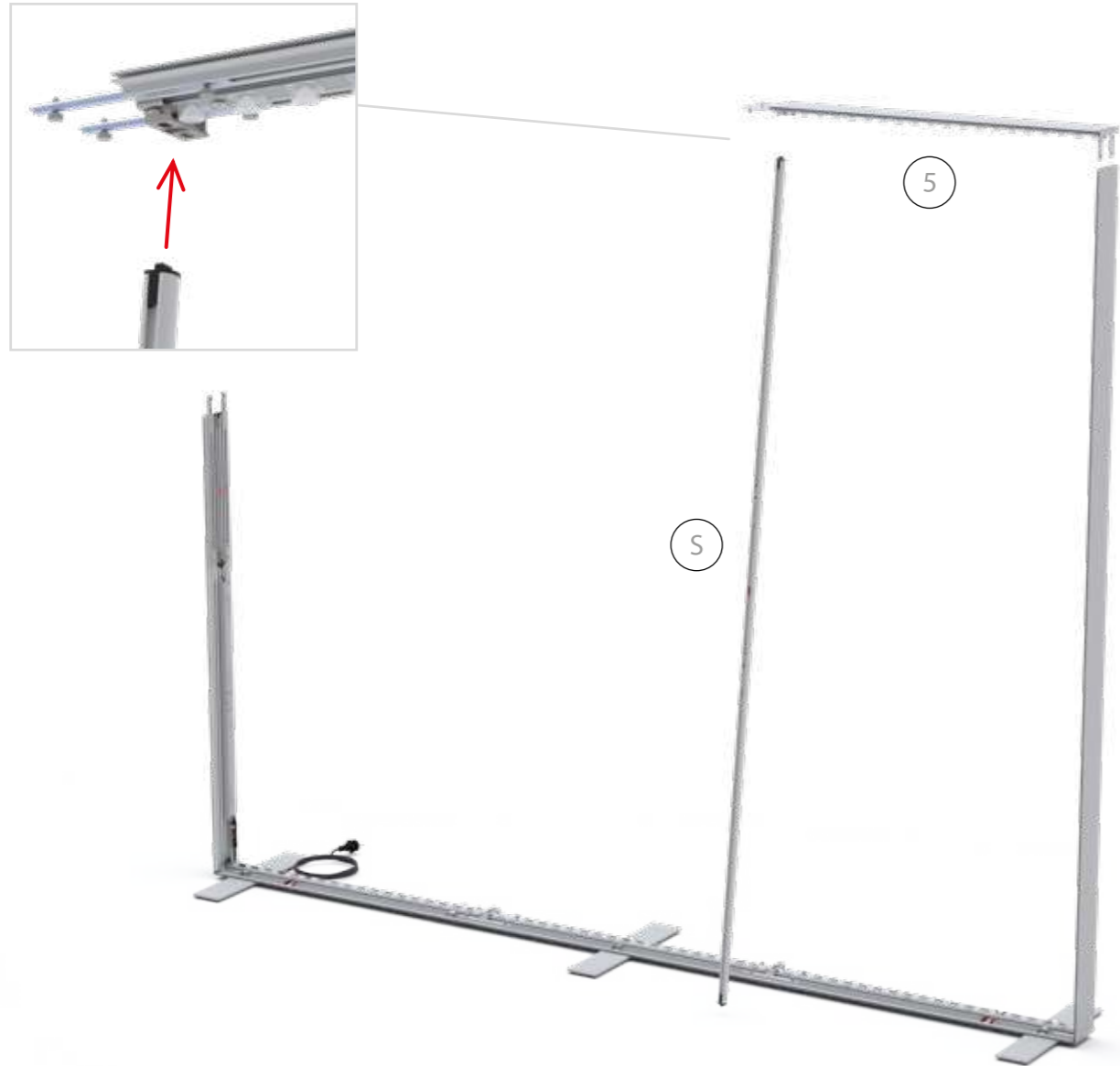

15.

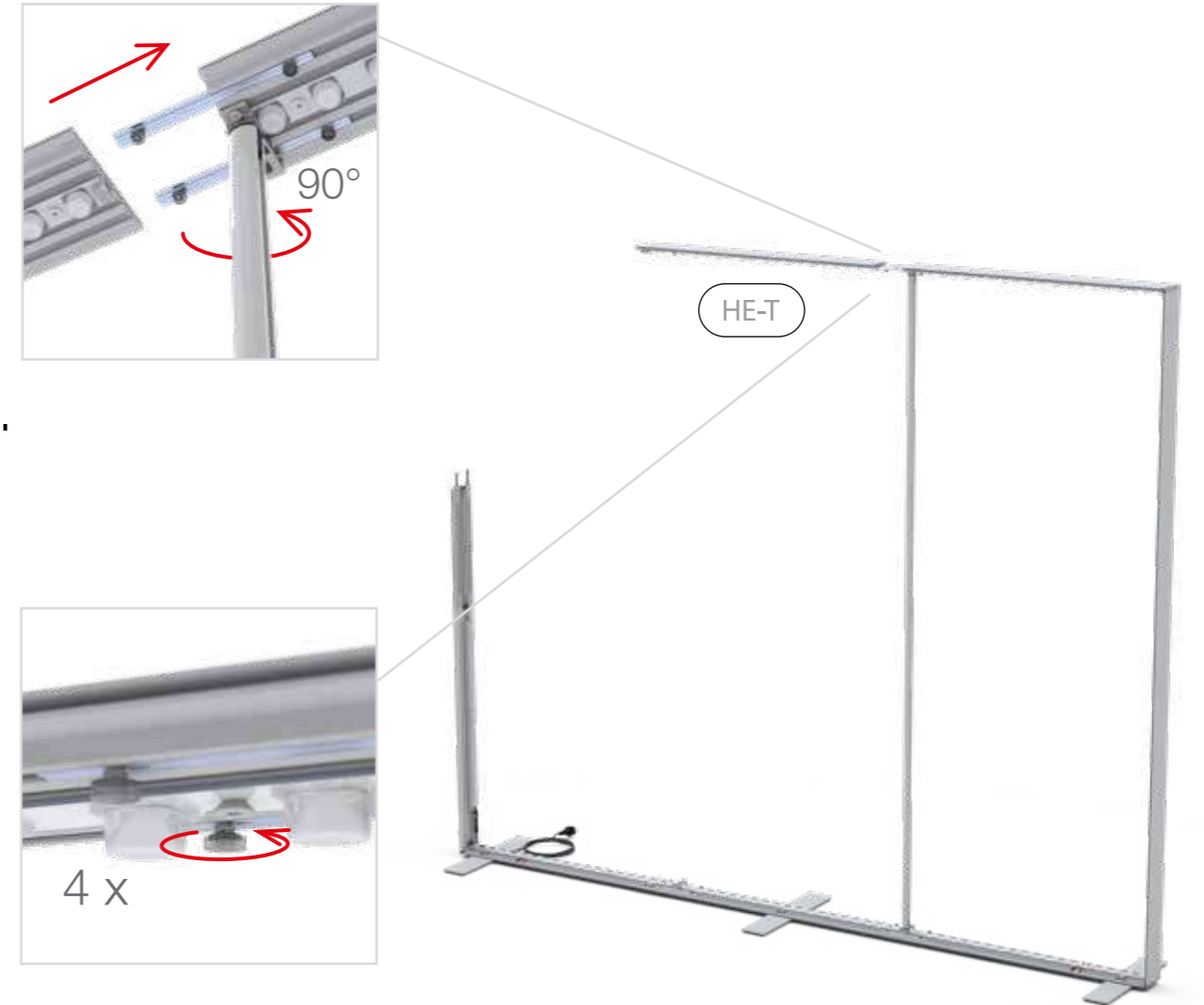

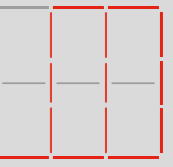
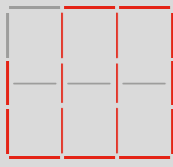

16.



17.



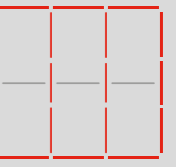
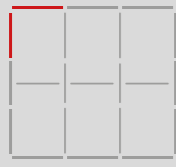

18.



19.

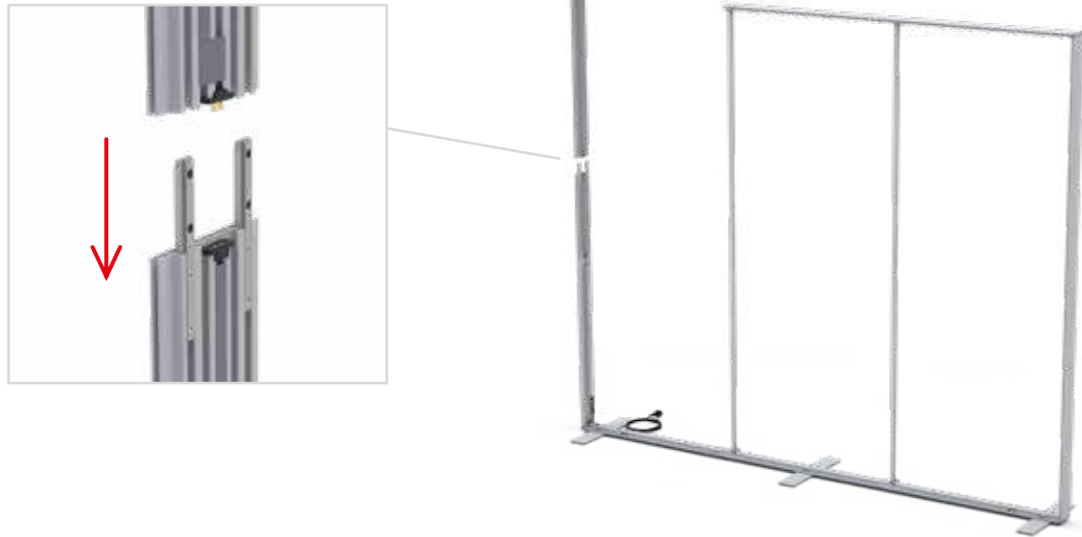

20.

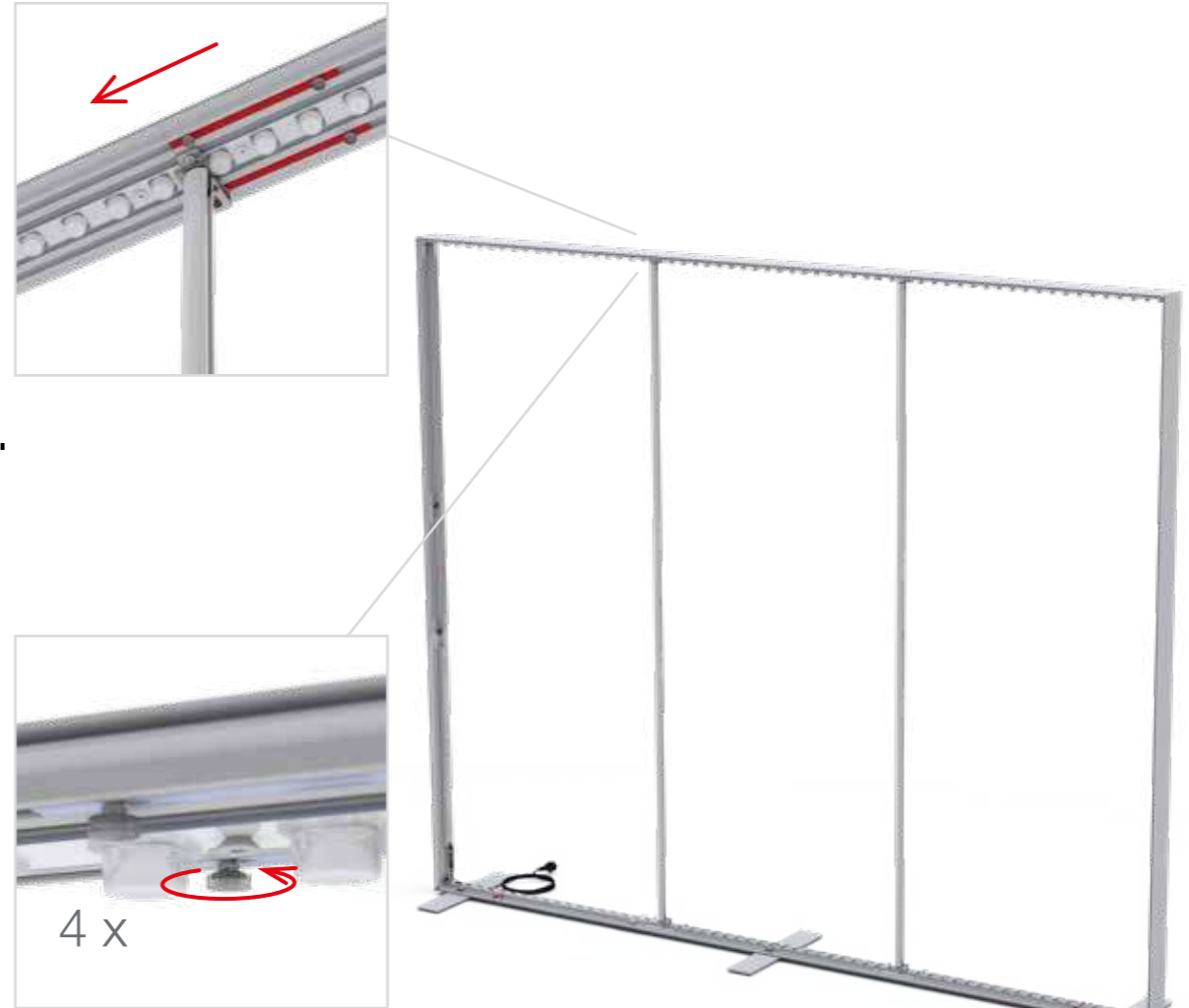

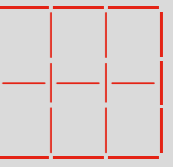
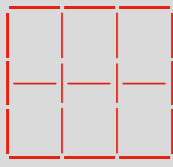

21.

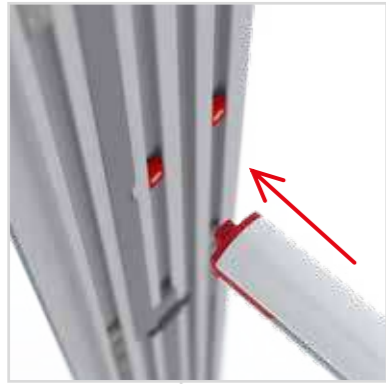

22.

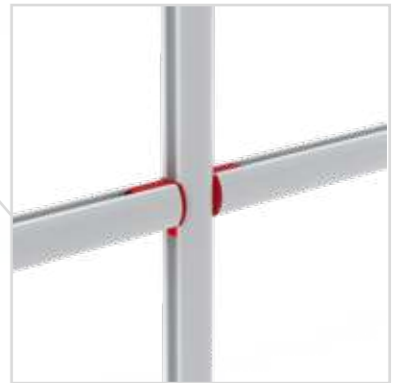

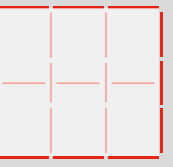
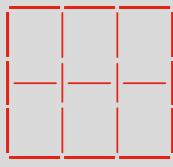

23.

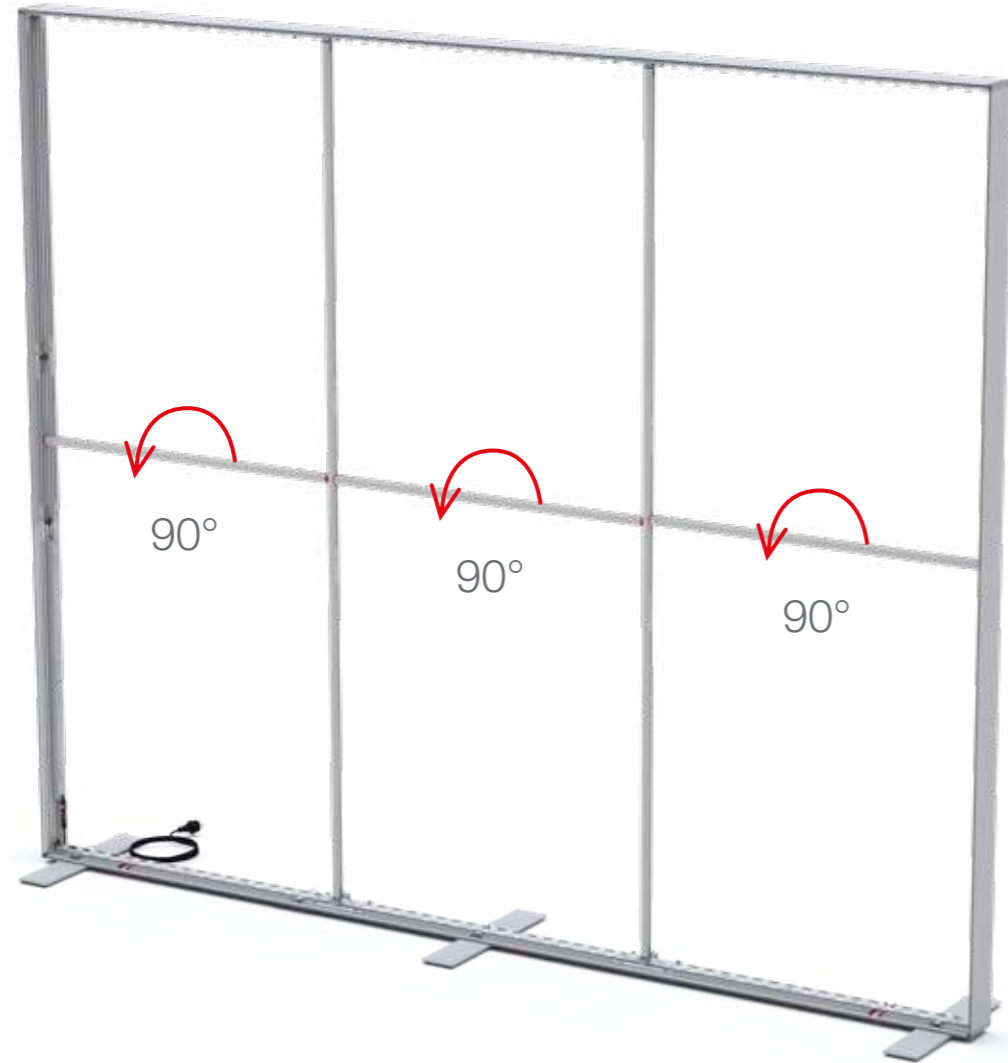

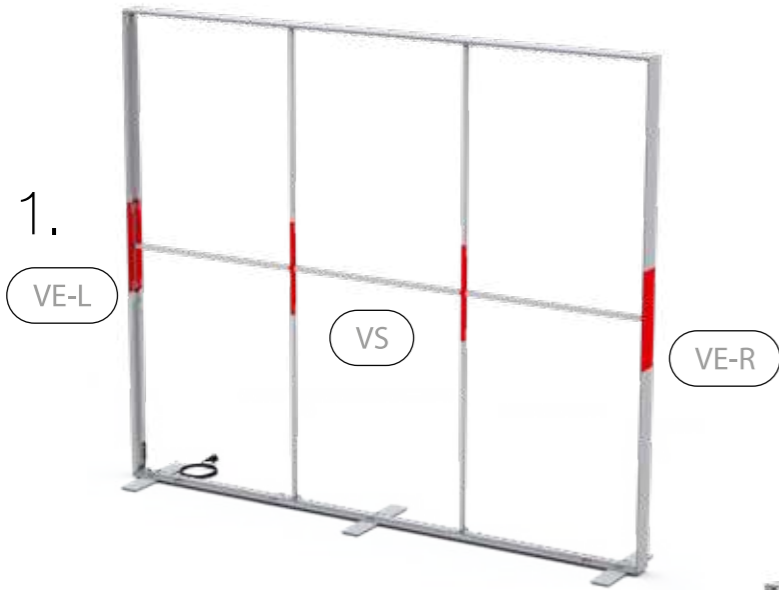

ZUBEHÖR
ACCESSORIES



BIG LED UP

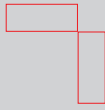
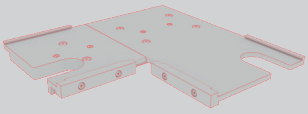

BLUP-conn-90

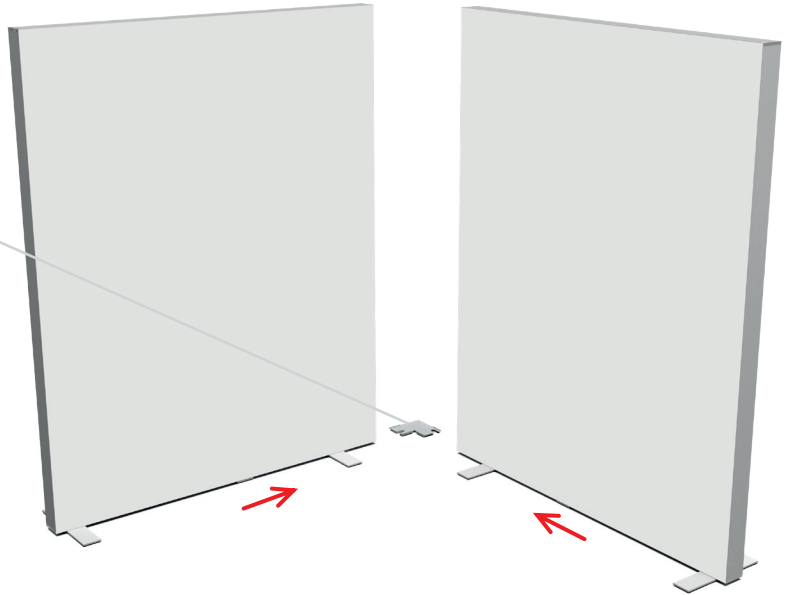

1.

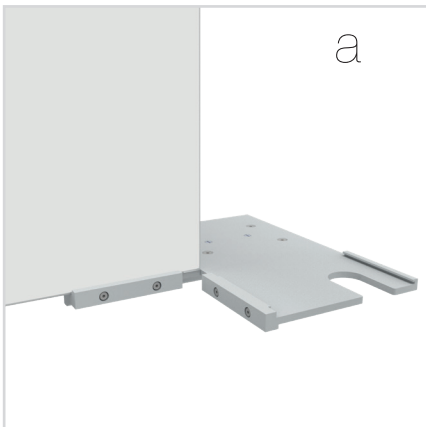

a

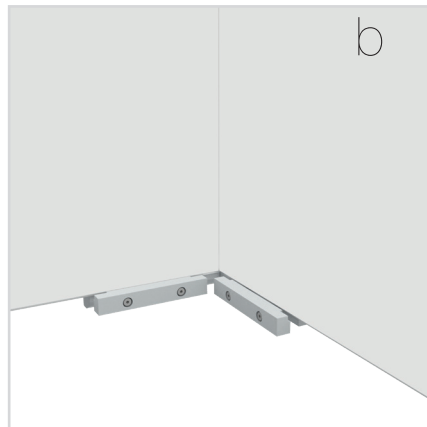

b

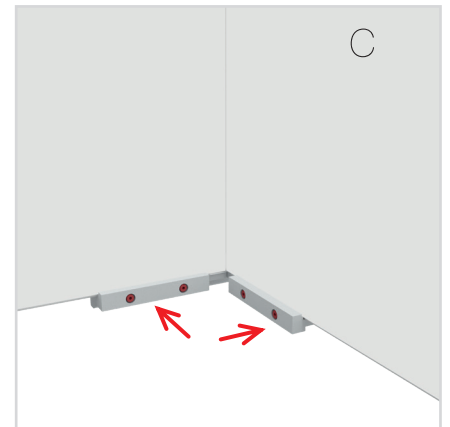

c

ECK KLEMME/ CORNER CLAMP

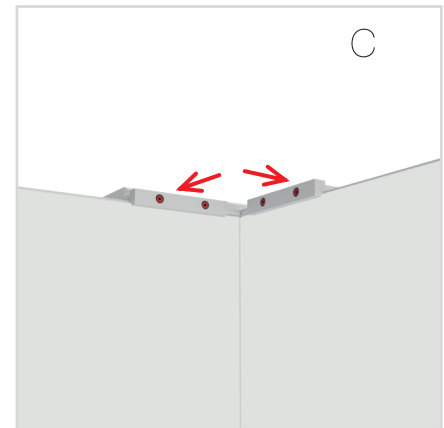
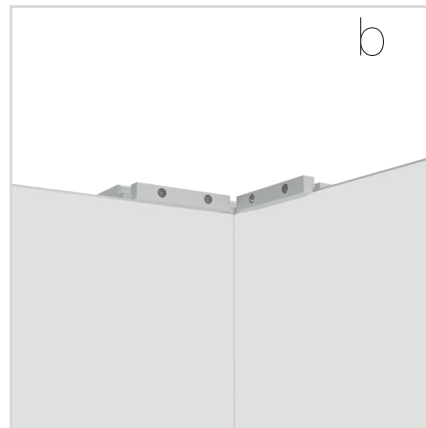
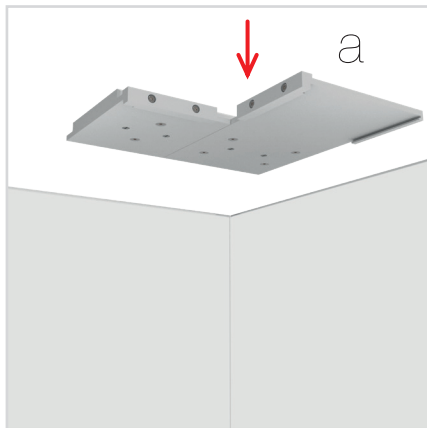
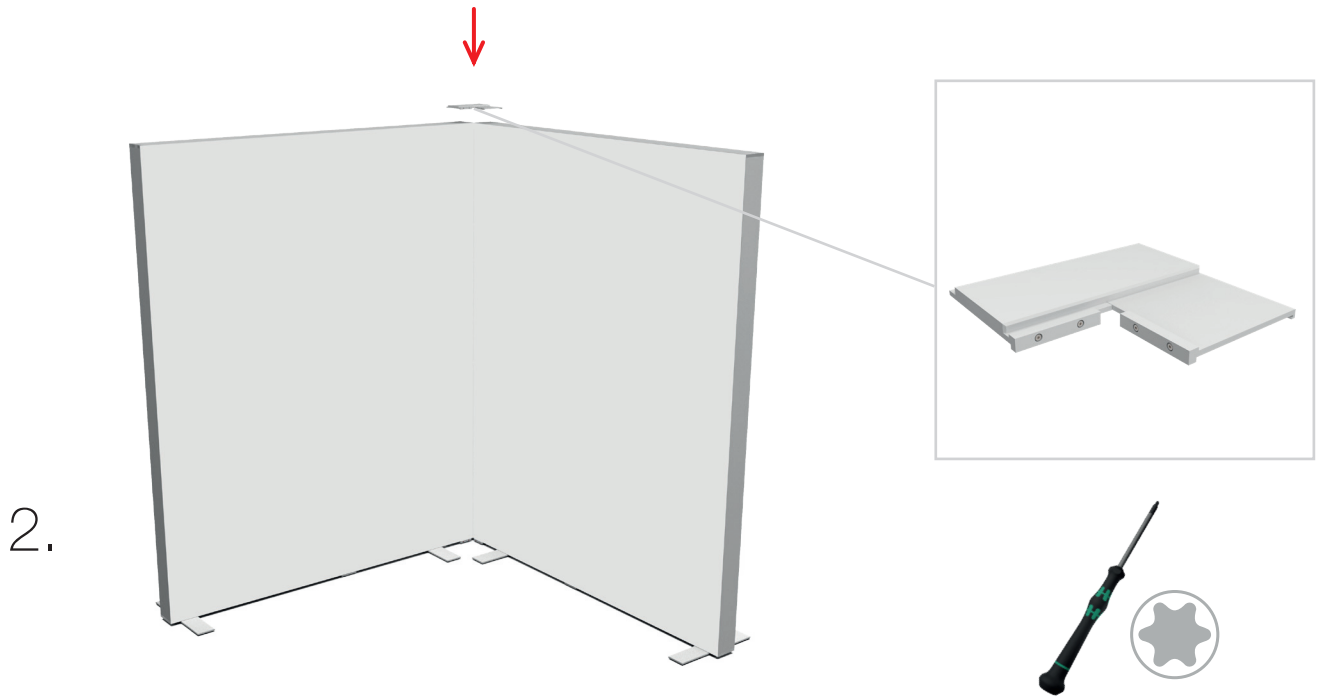



AUFBAUANLEITUNG SETUP INSTRUCTION



COUNTER

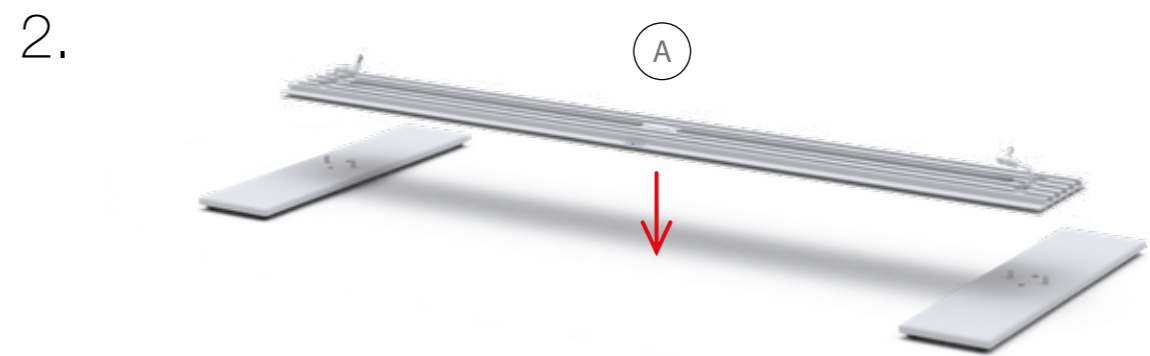
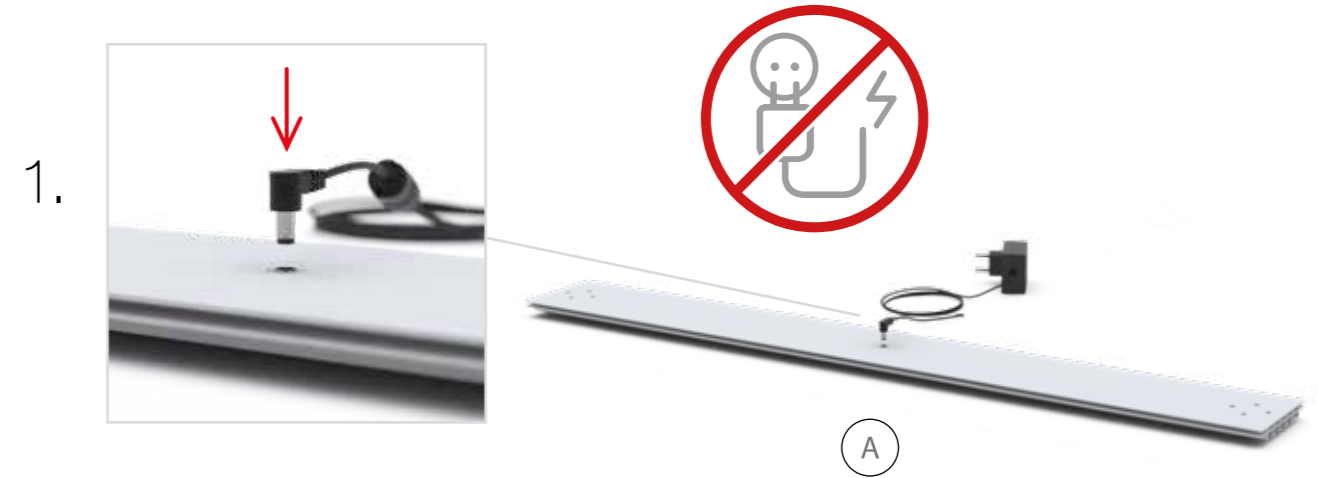

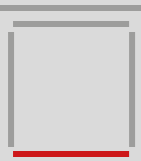

3.

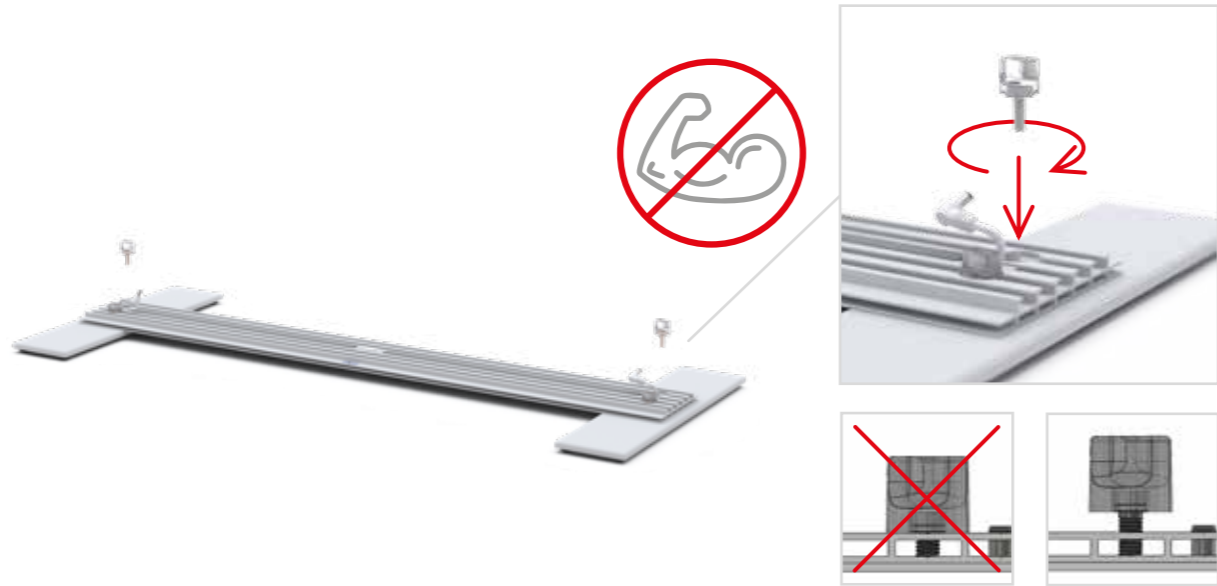

4.

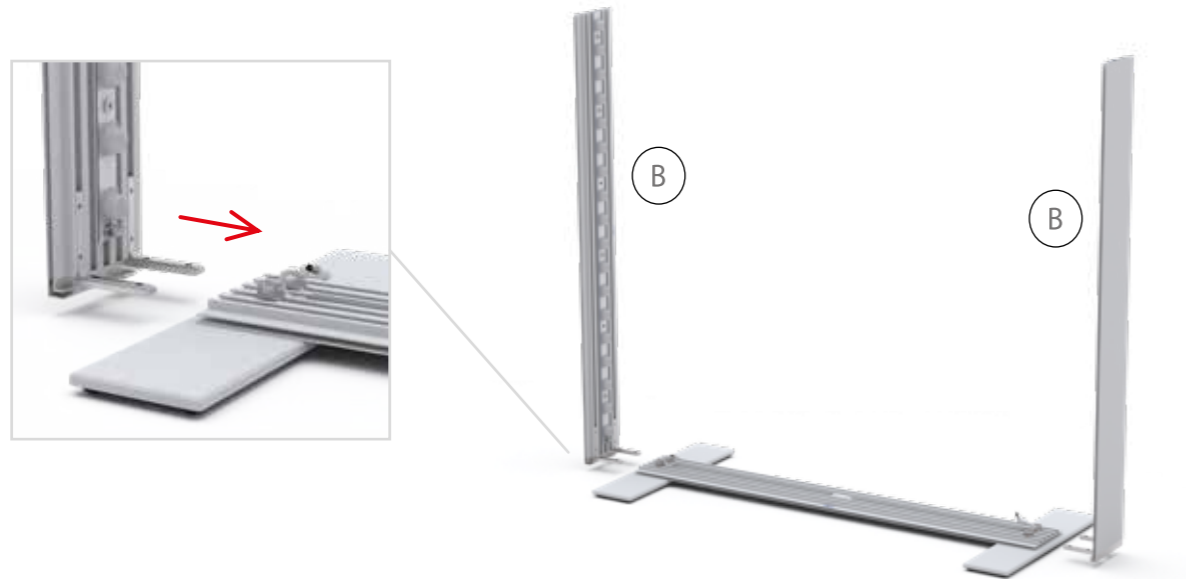

5.

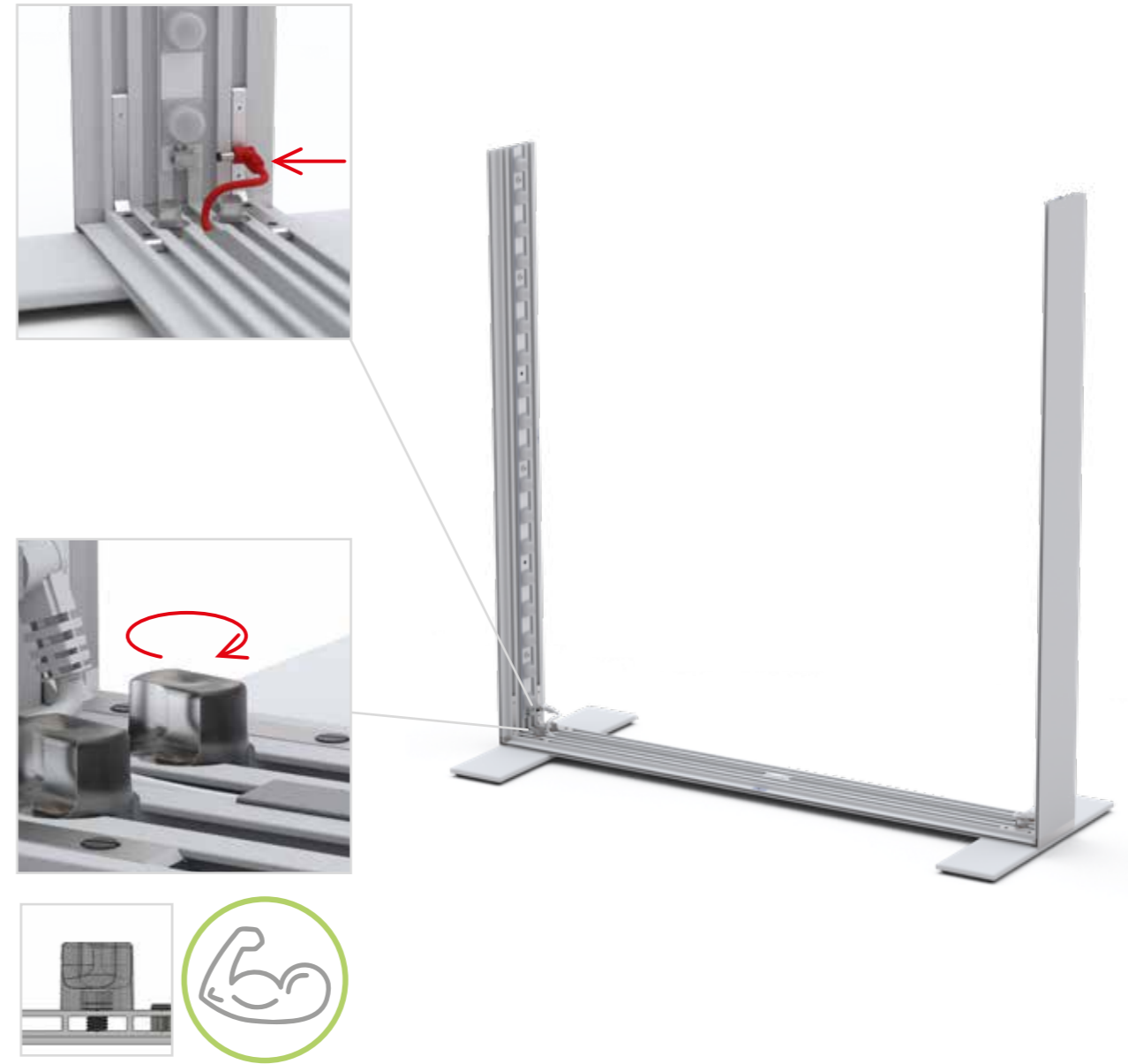

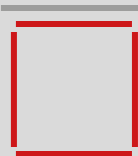
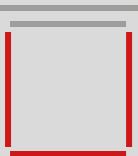

6.



7.



8.





9.



10.

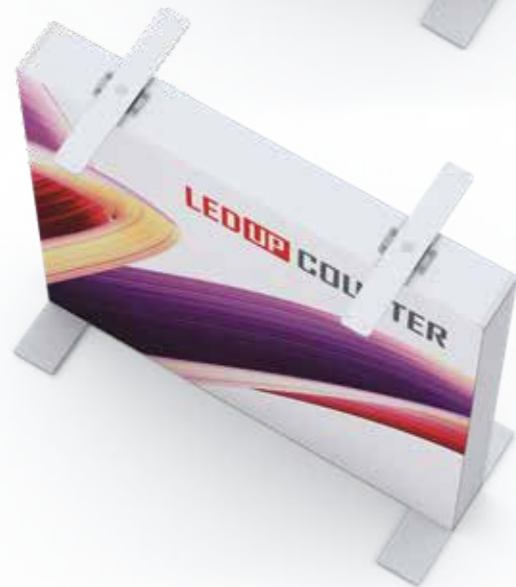

11.



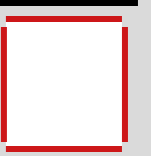
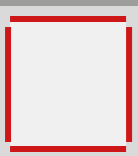

12.

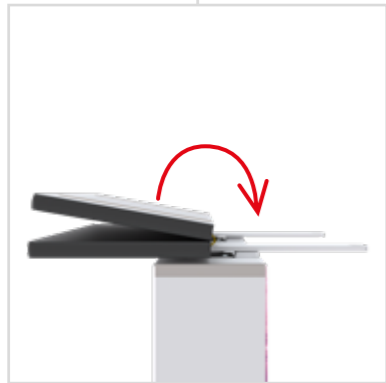

13.

