

AUFBAUANLEITUNG SET UP INSTRUCTION

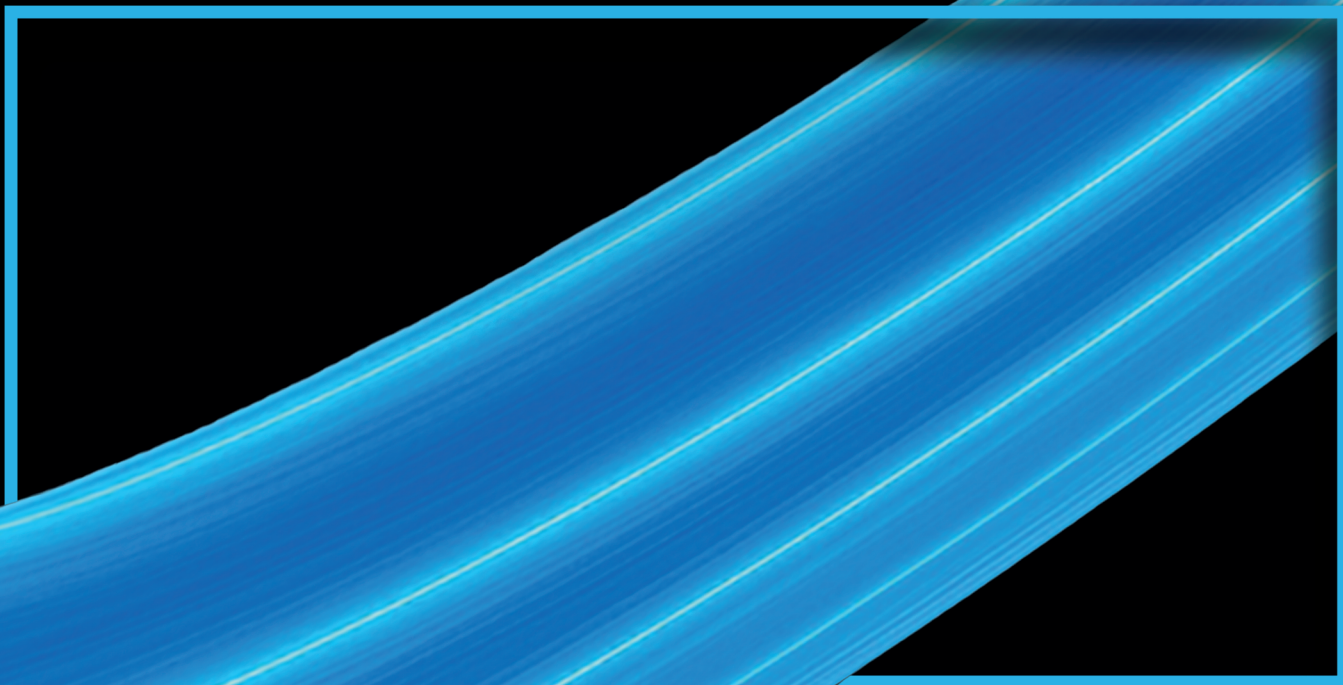

LINEUP

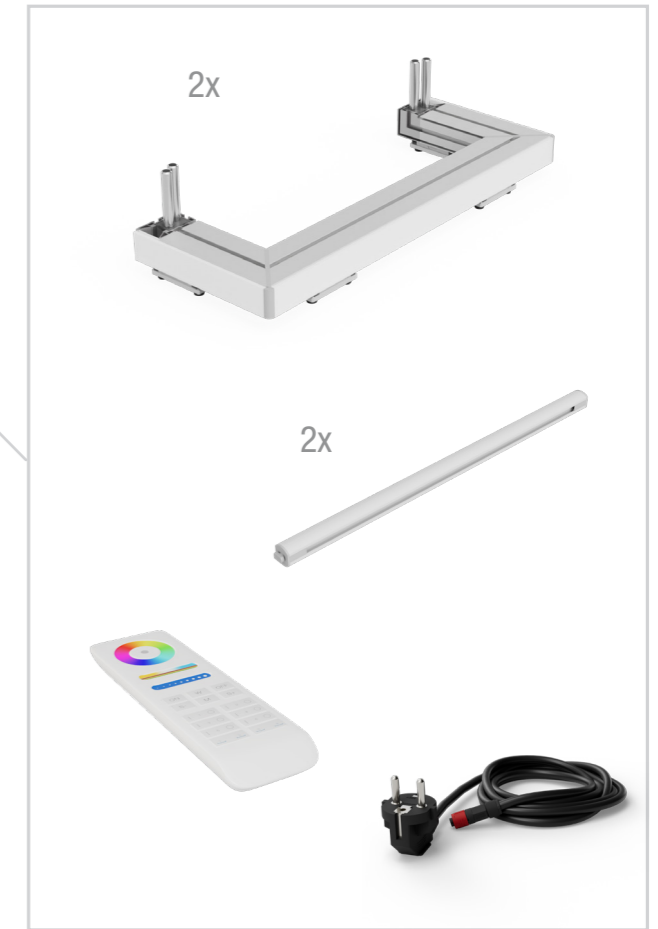

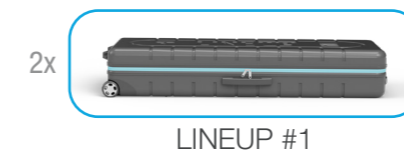
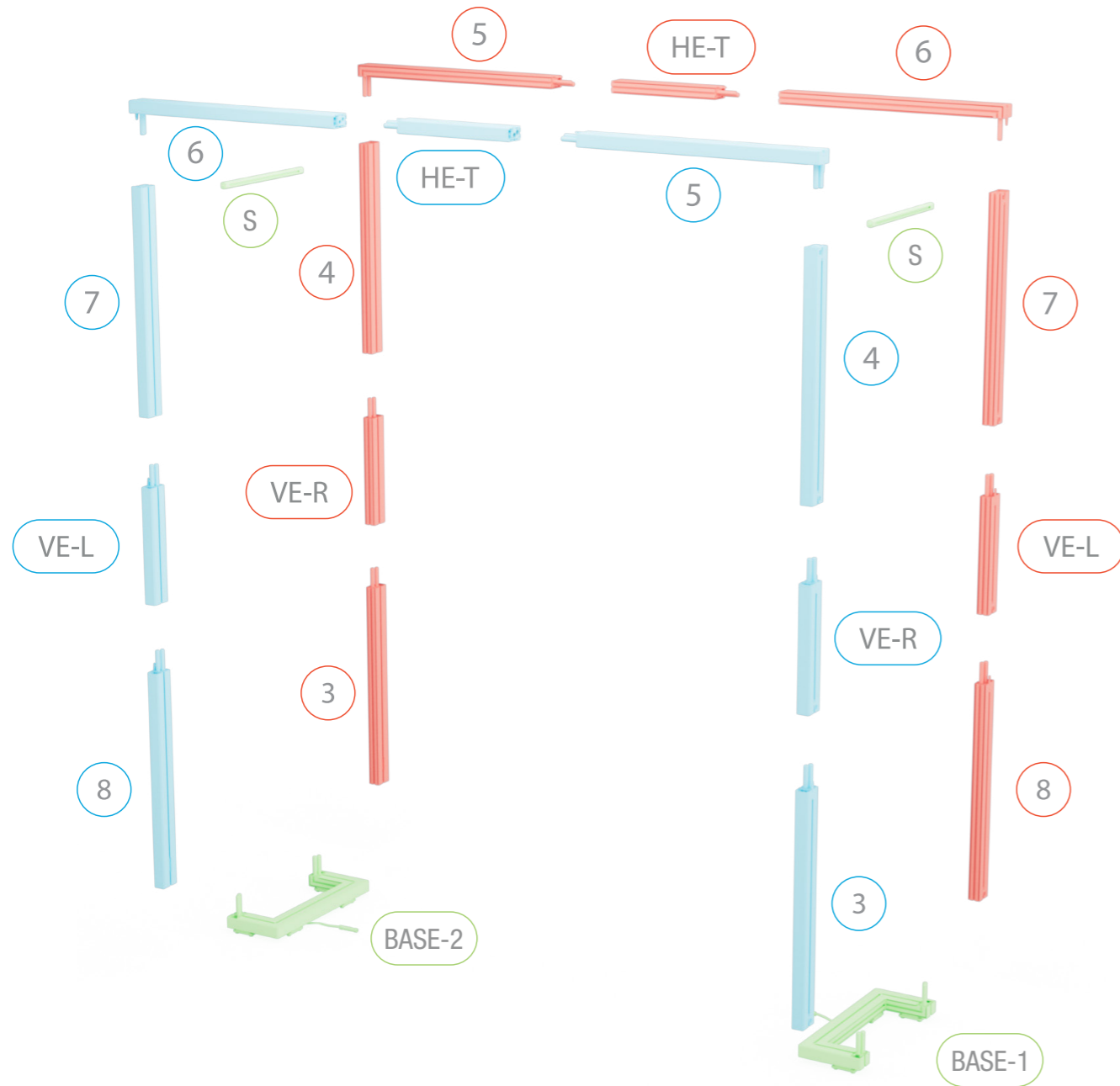
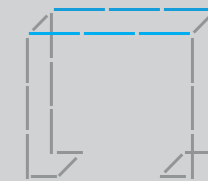
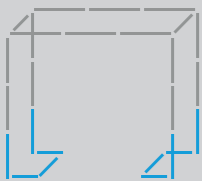

1.

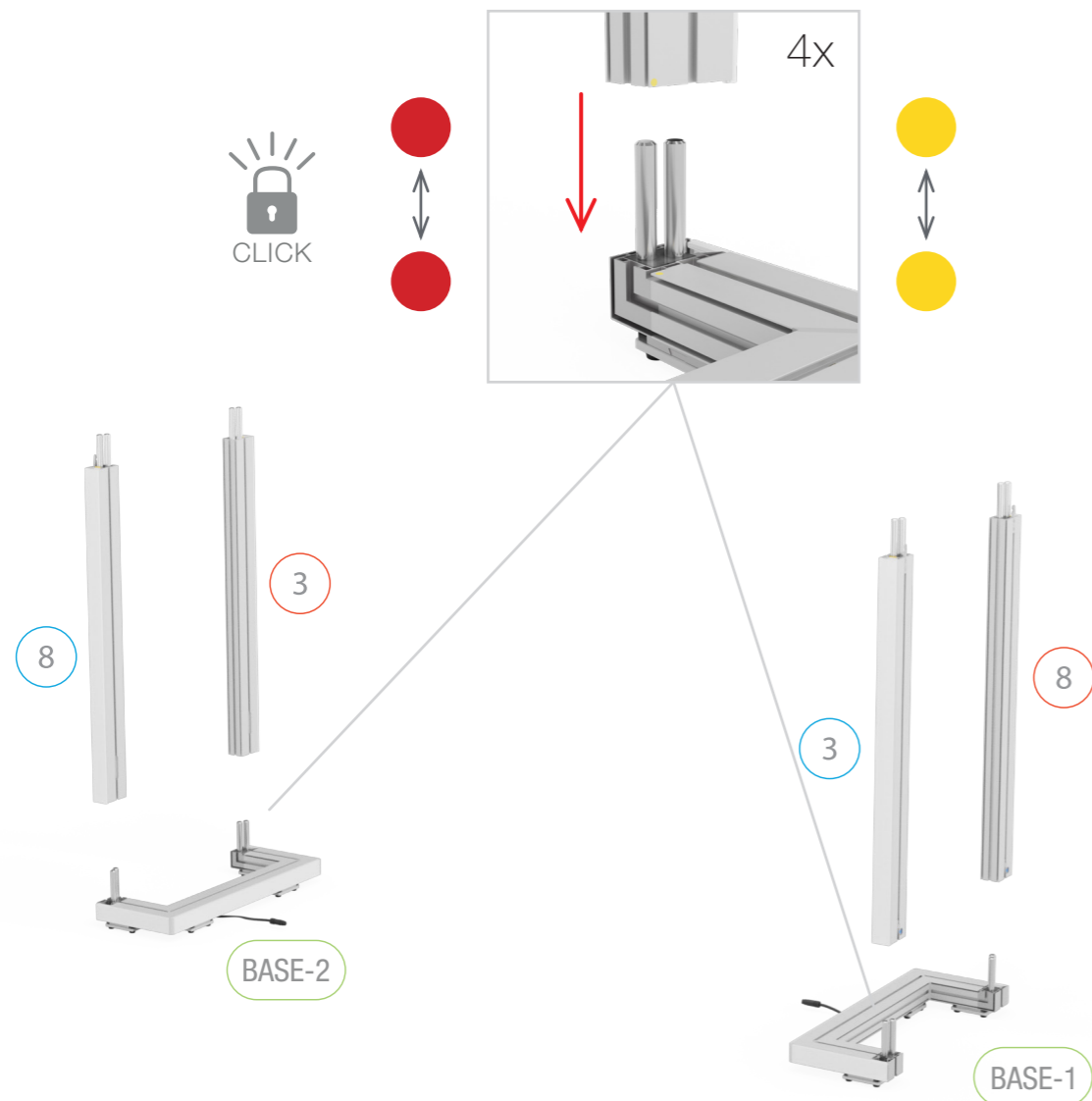

2.

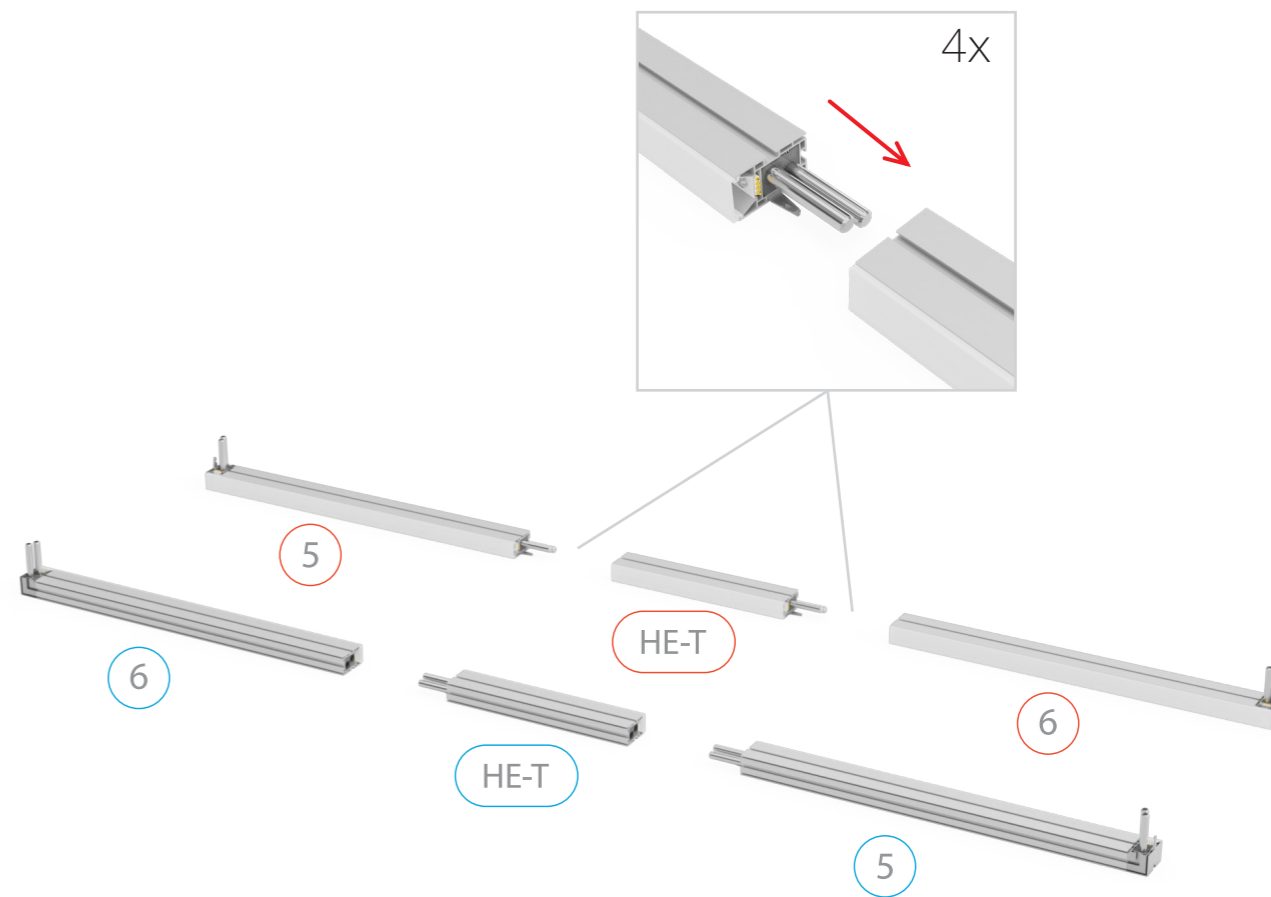

3.

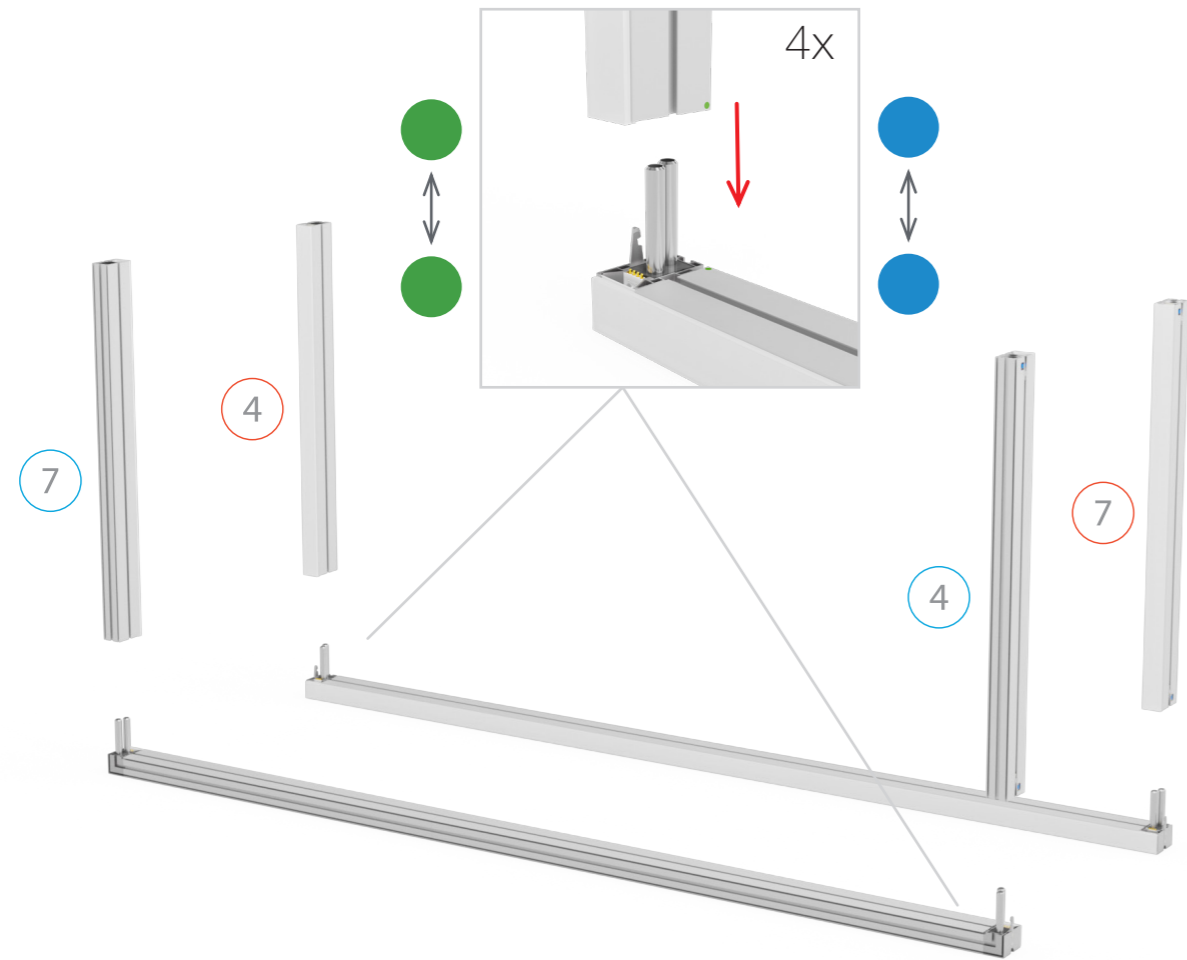

4.

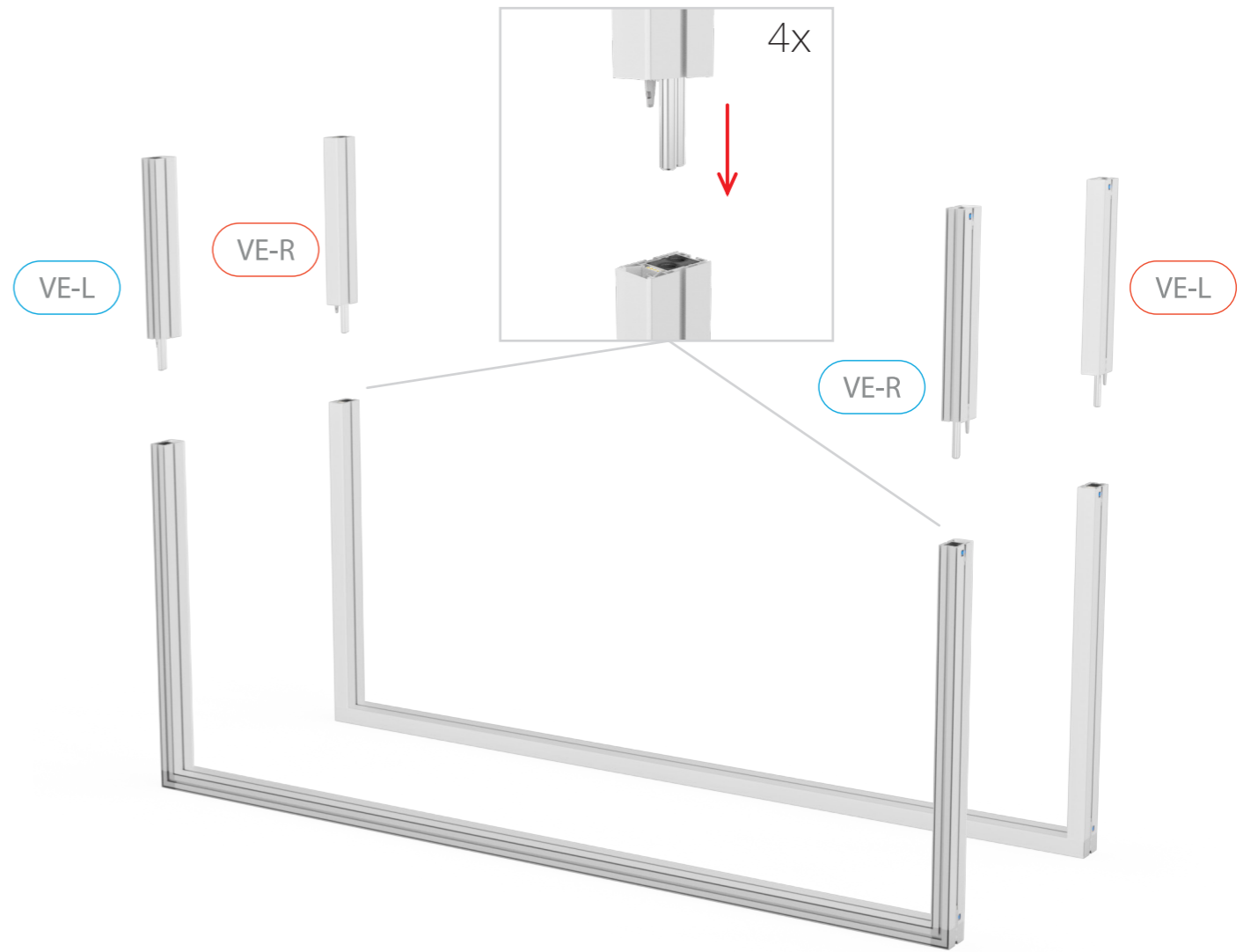

5.

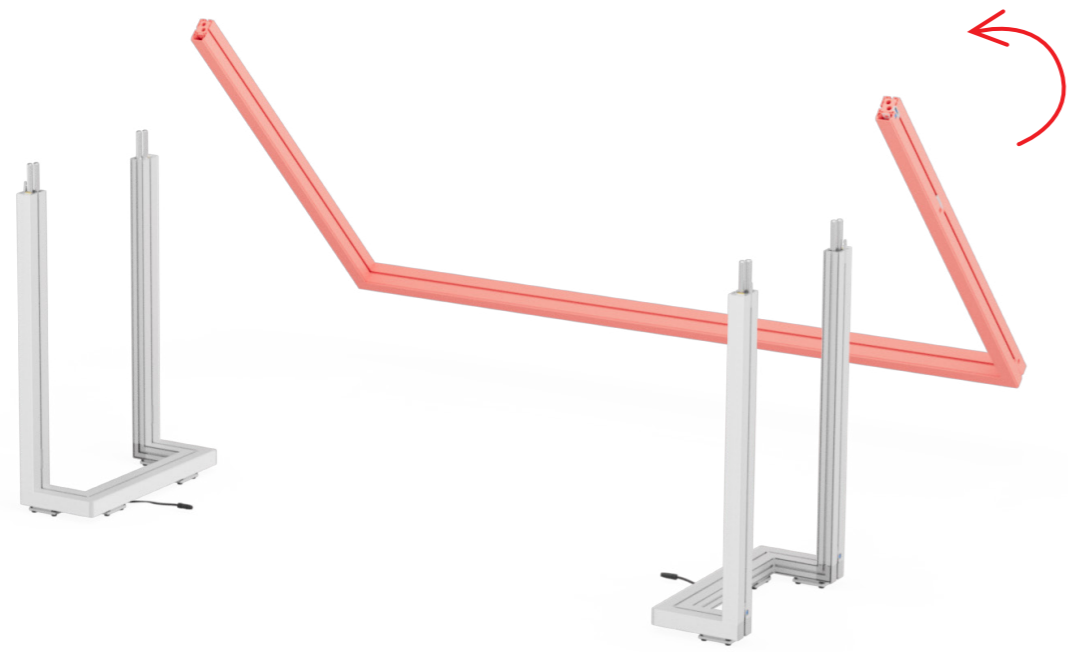

6.

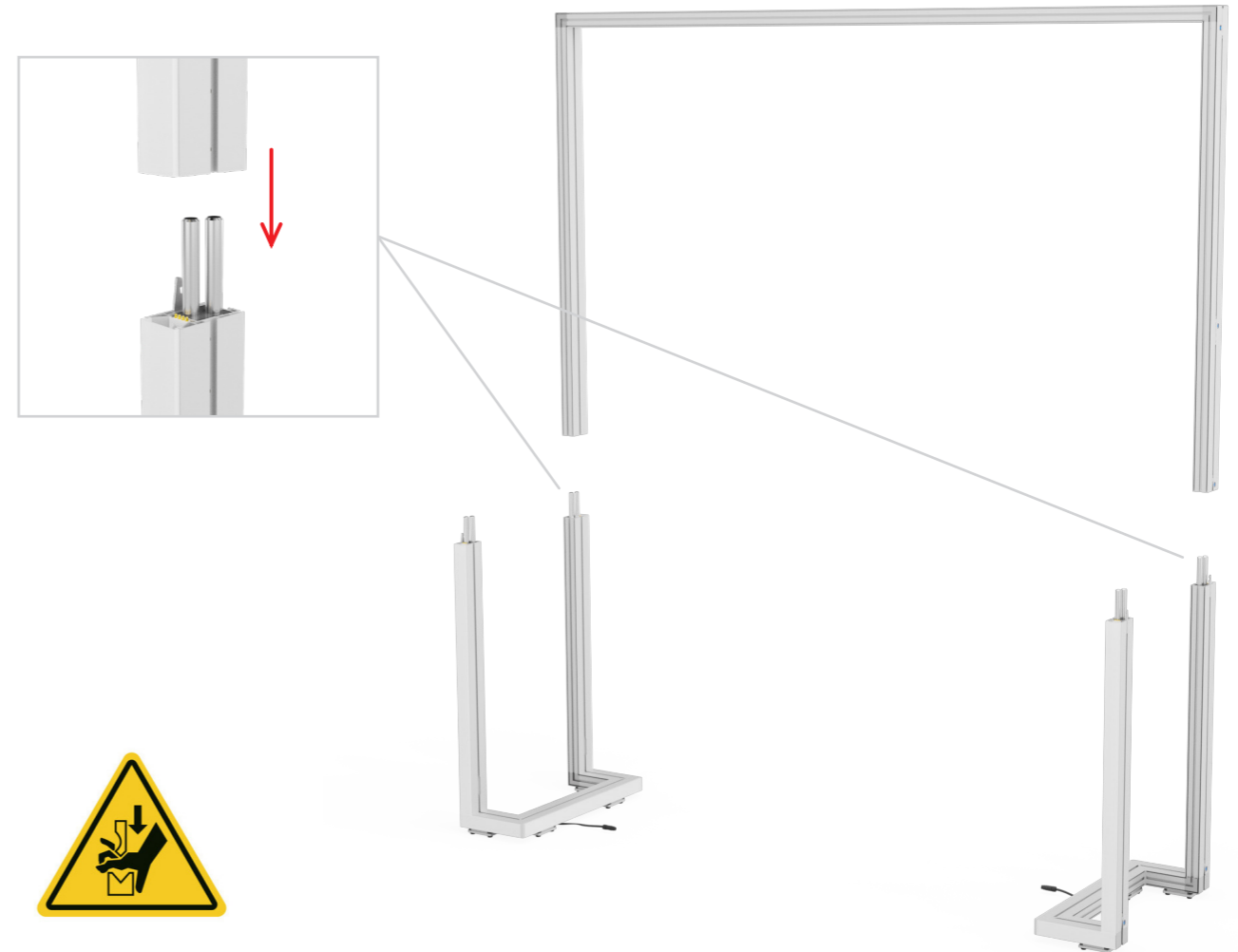

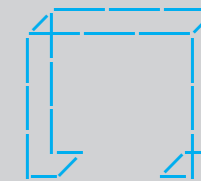
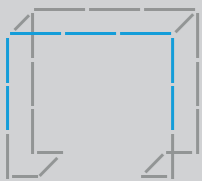

7.

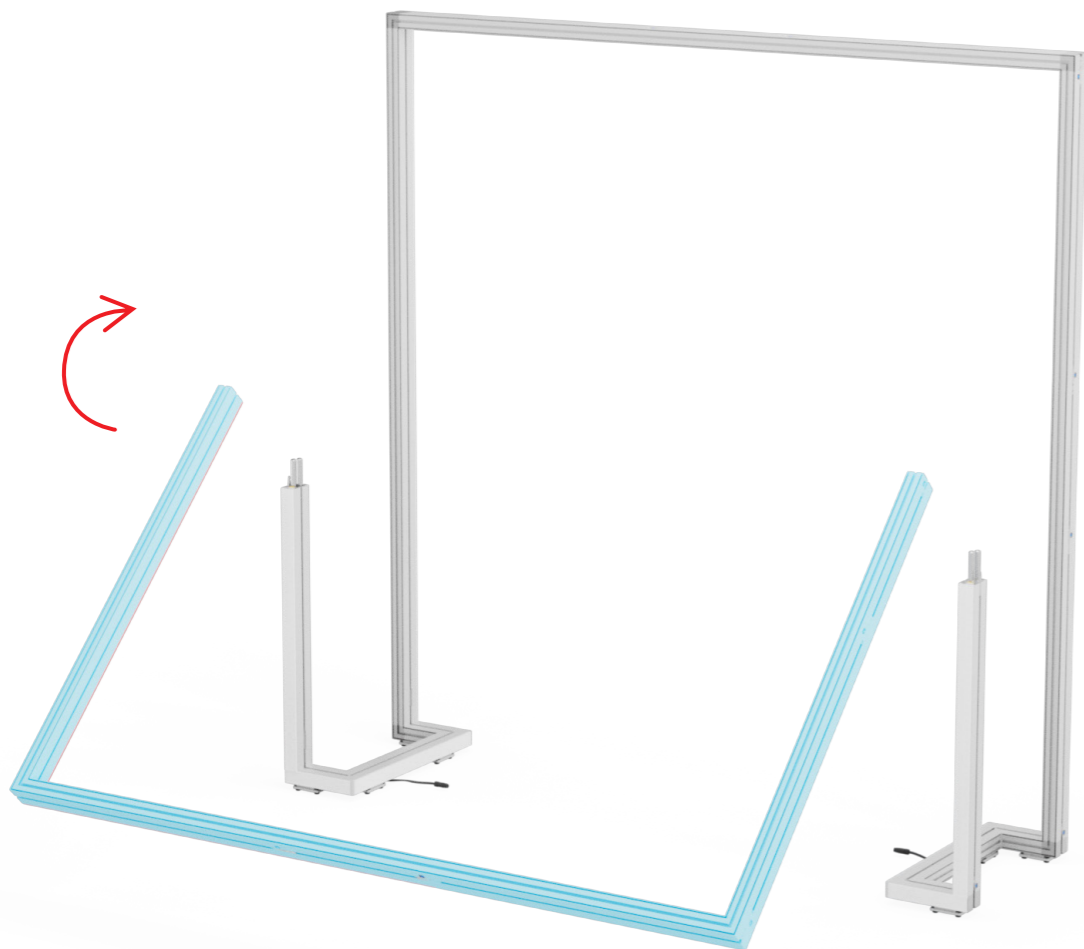

8.

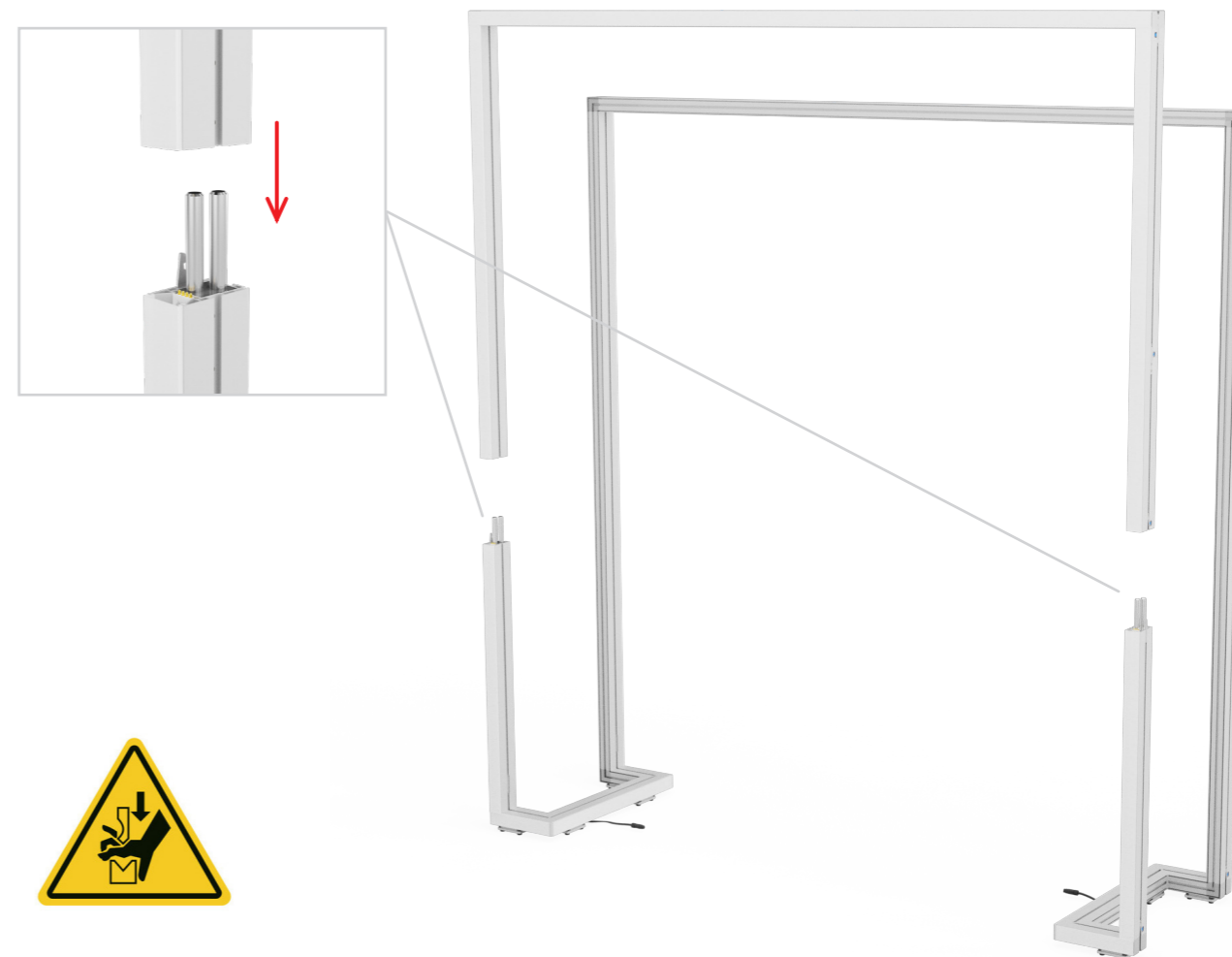

9.

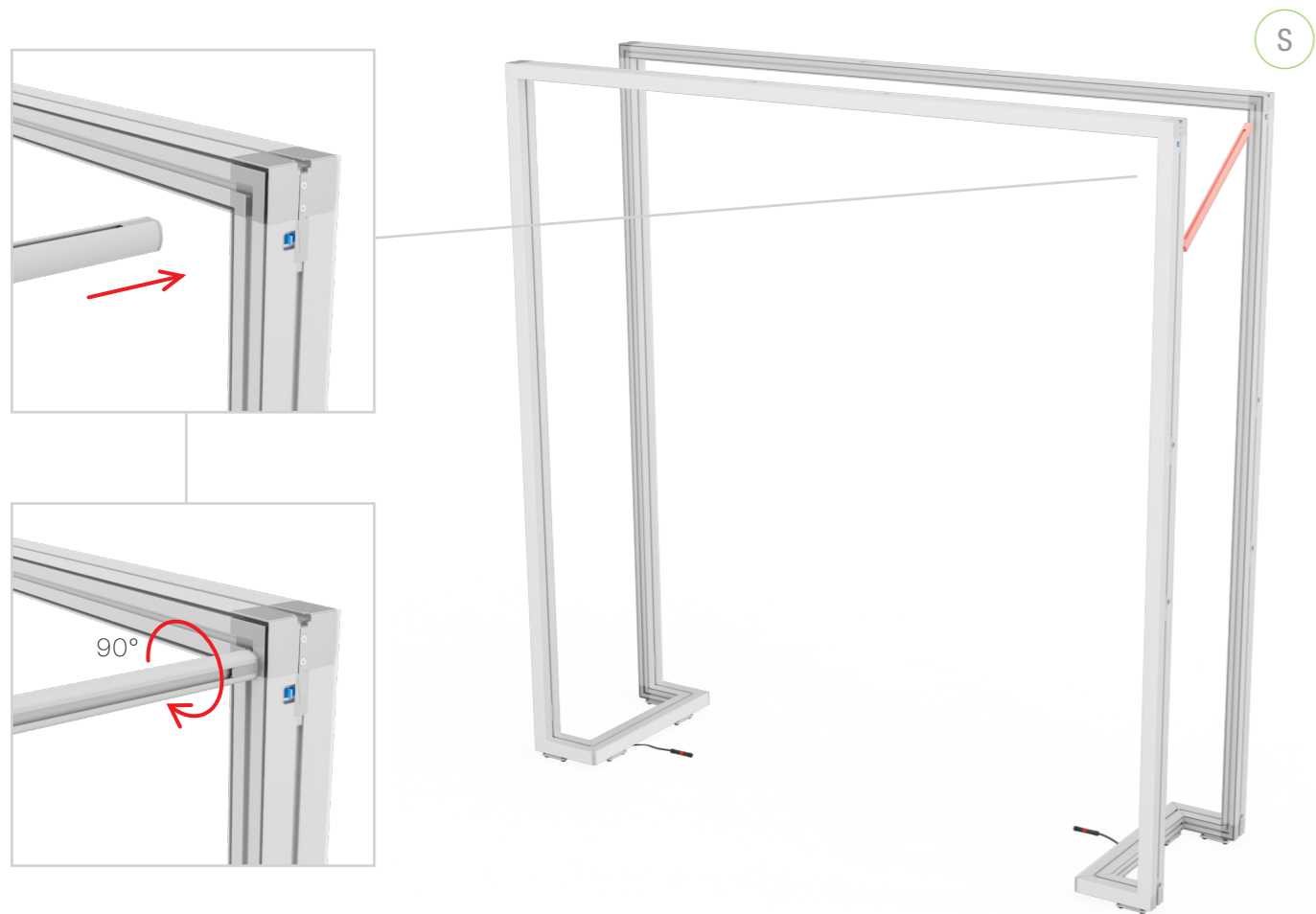

10.

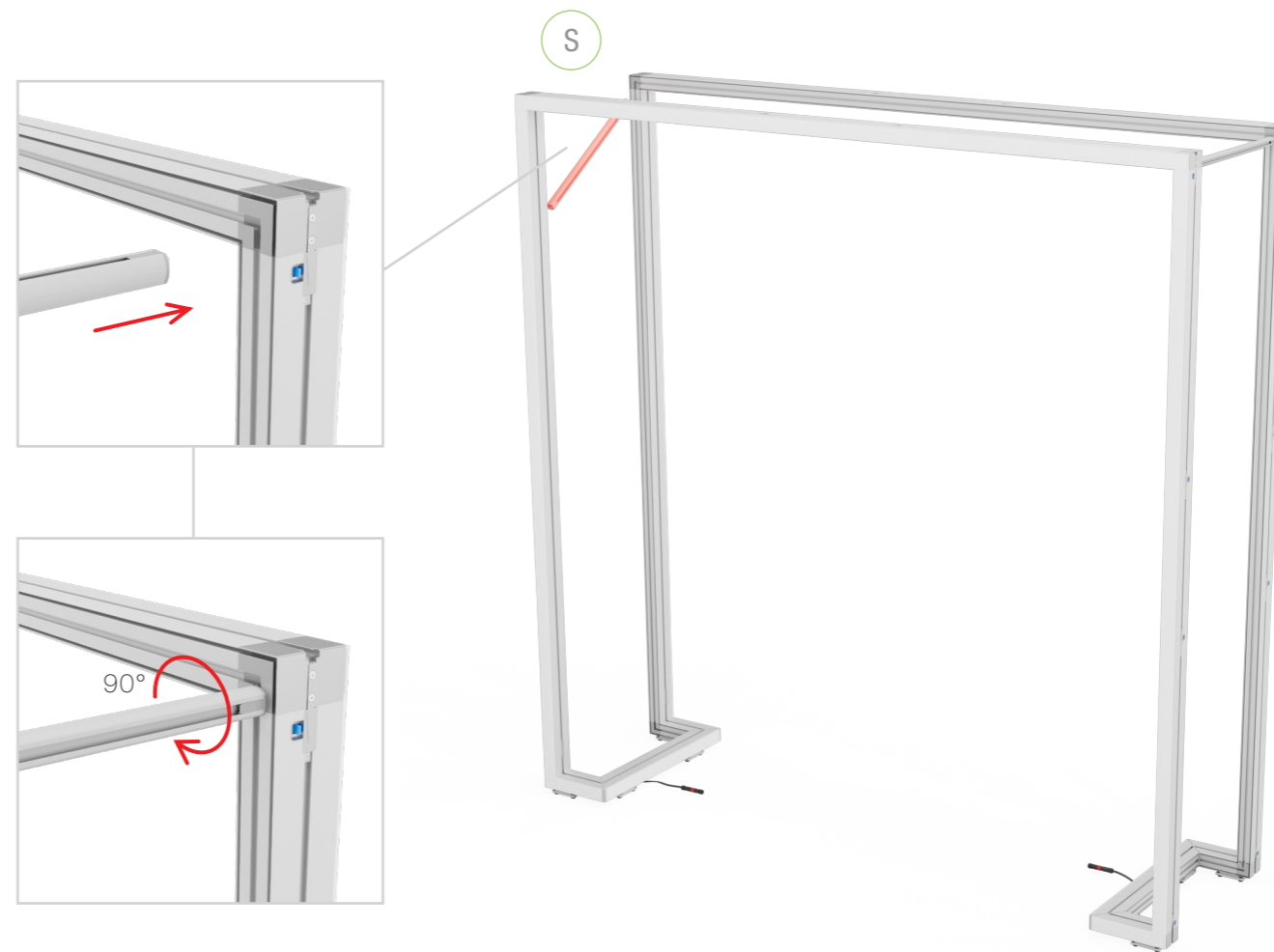

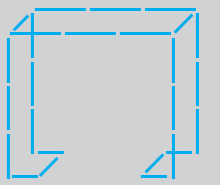
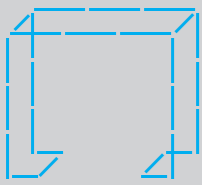

11.

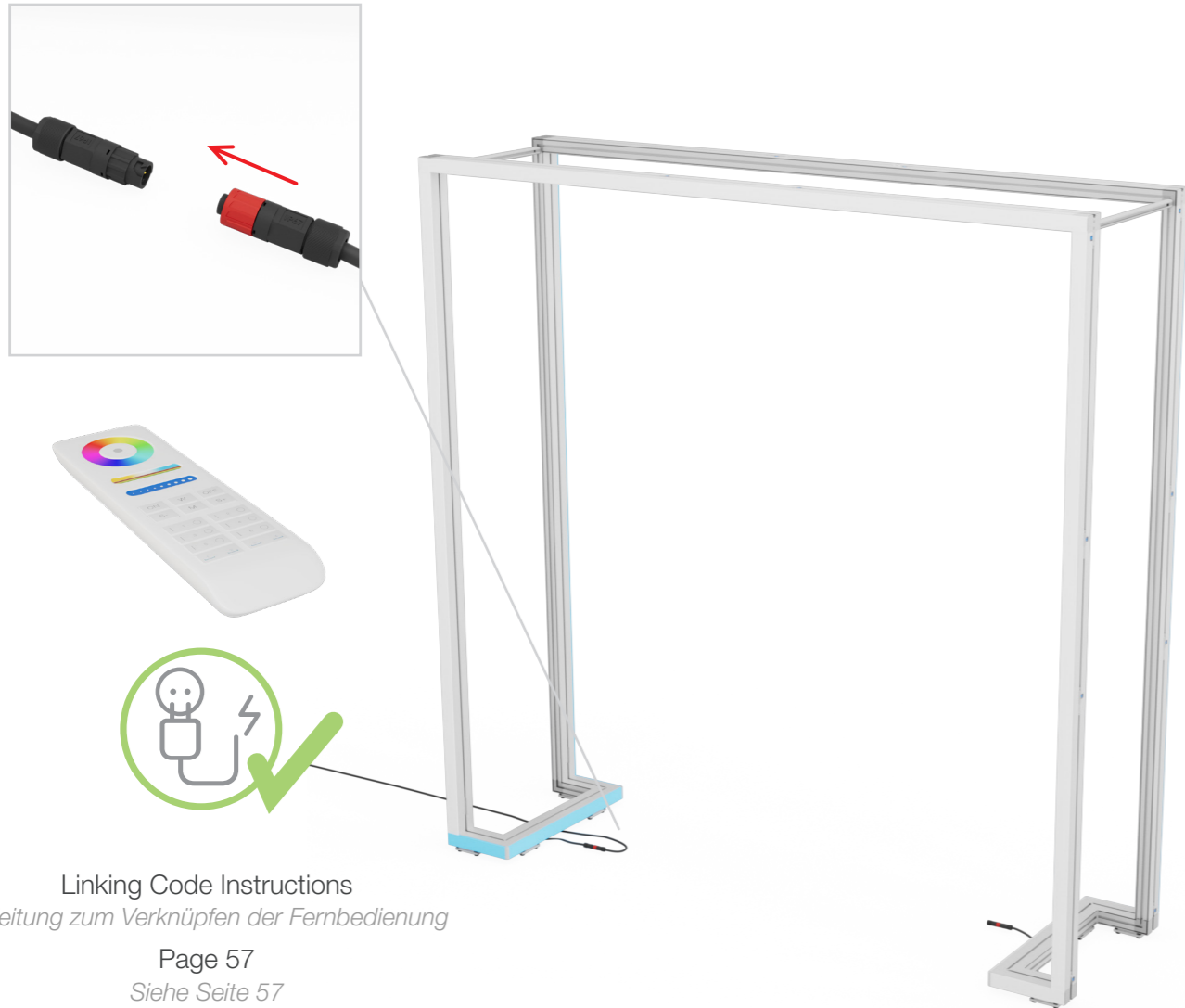

Linking Code Instructions
 Anleitung zum Verknüpfen der Fernbedienung
 Page 57
 Siehe Seite 57

12.

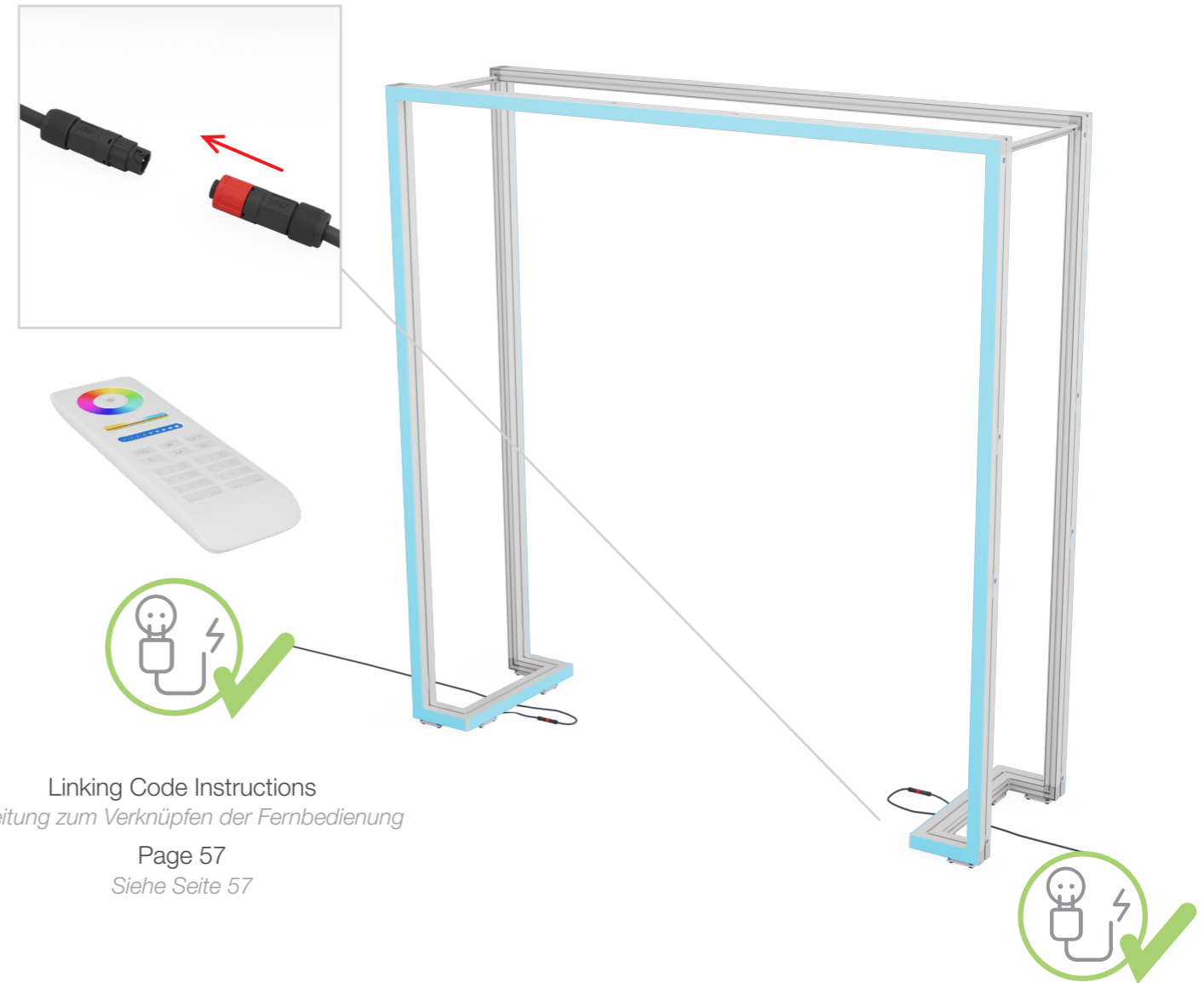

Linking Code Instructions
 Anleitung zum Verknüpfen der Fernbedienung
 Page 57
 Siehe Seite 57

6-Zone RGB LINEUP Remote

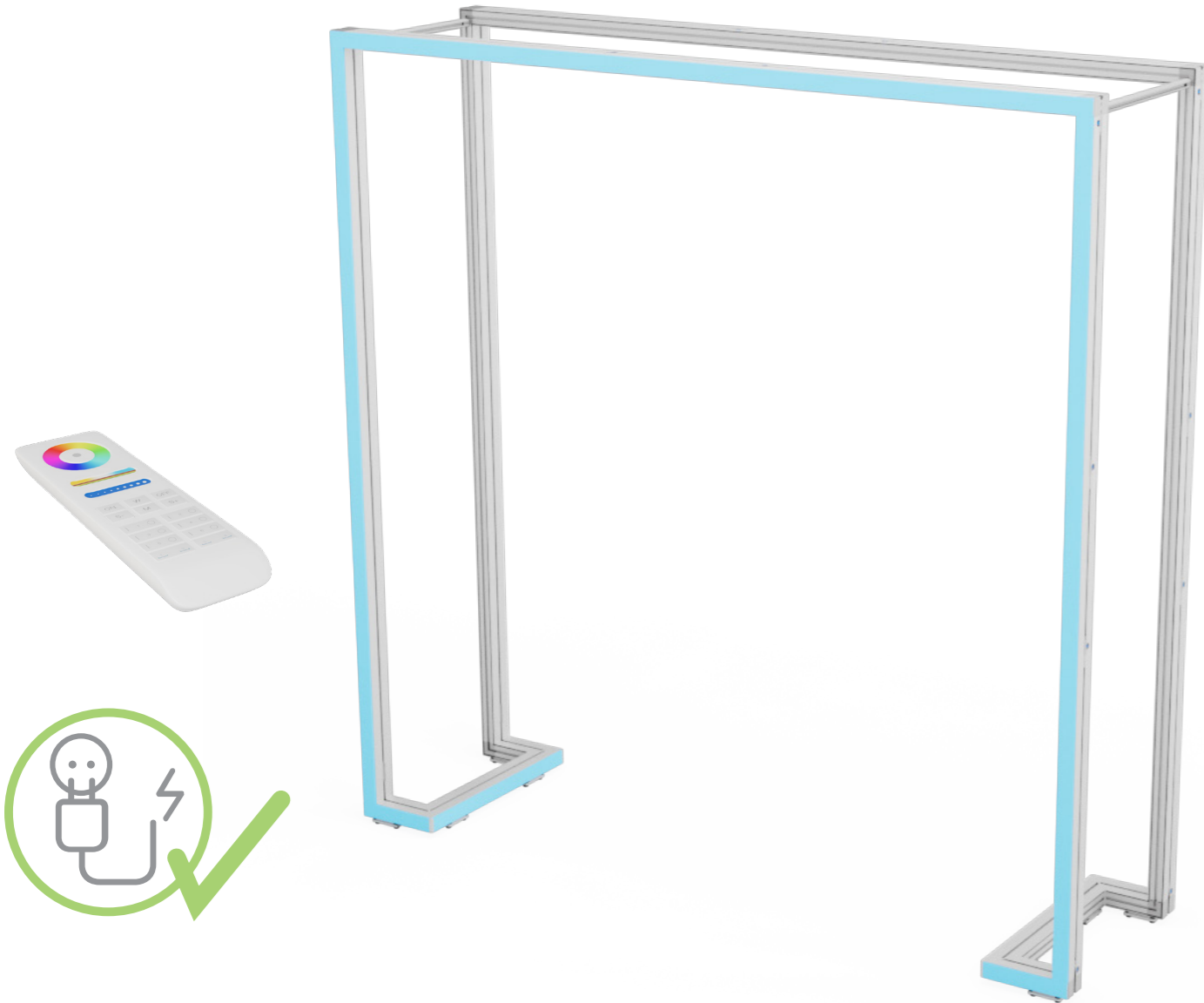

Linking Code Instructions *Anleitung zum Verknüpfen der Fernbedienung*



1

Disconnect the LINEUP frame from the power supply for 10 seconds, then reconnect it.

Stromversorgung des LINEUP-Rahmens für 10 Sekunden unterbrechen und wiederherstellen.

2

Short press "1" button 3 times within 3 seconds when light on.

Drücken Sie die Taste "1" 3 mal innerhalb von 3 Sekunden, wenn das Licht an ist.

3

Lights blink 3 times slowly means linking is done successfully.

Die Beleuchtung blinkt 3 mal langsam, dass bedeutet die Verknüpfung wurde erfolgreich durchgeführt.



Linking failed if light is not blinking slowly, Please follow above steps again.
(Note: Light that have linked can't link again)

*Die Verknüpfung ist fehlgeschlagen, wenn das Licht nicht langsam blinkt.
Bitte befolgen Sie die obigen Schritte erneut.
(Hinweis: Licht, welches verknüpft ist, kann nicht erneut verknüpft werden)*

